

ORDINANCE NO. NS-1200.371

AN ORDINANCE OF THE BOARD OF SUPERVISORS OF THE COUNTY OF SANTA CLARA AMENDING APPENDIX I, ZONING, OF THE COUNTY OF SANTA CLARA ORDINANCE CODE TO MODIFY ACCESSORY DWELLING UNIT REGULATIONS

Summary

This ordinance amends Appendix I, Zoning, of the County of Santa Clara Ordinance Code, to modify definitions, use classifications, and permitting requirements for accessory dwelling units and junior accessory dwelling units in accordance with recent amendments to state law, and allowing the use of movable tiny homes as accessory dwelling units.

THE BOARD OF SUPERVISORS OF THE COUNTY OF SANTA CLARA ORDAINS AS FOLLOWS:

SECTION 1. Section 1.30.030 of Chapter 1.30, Article 1 of Appendix I, Zoning, of the County of Santa Clara Ordinance Code, is amended as follows:

§1.30.030 Definition of Terms

Accessory structure: A structure or building that is auxiliary and subordinate to the main structure or building on a lot, except as otherwise provided herein. Any building that is incidental to the conduct of any agricultural use shall be considered to be an agricultural accessory building. For purposes of this zoning ordinance, no building designed, intended or used for dwelling purposes shall be considered to be an accessory structure.

Accessory use: A use related to, but auxiliary and subordinate to the primary use on a lot.

Agriculture-serving use: A use that supports the agricultural industry including but not limited to shipping and trucking operations, manufacturing and sales of farm and nursery equipment and supplies, large animal hospitals, and other service providers catering specifically to the agriculture industry.

Alley: Any public thoroughfare, not exceeding 30 feet in width, for the use of pedestrians or vehicles, or both, that affords only a secondary means of access to abutting property.

Animal, large: Animals characterized by their relative size to other animals and including but not limited to horses, cattle, bison and donkeys. Variants of species (e.g. miniature horses) may be reclassified as medium or small animals at the discretion of the zoning administrator.

Animal, medium: Animals characterized by their relative size to other animals and including but not limited to sheep, goats, pigs, ostriches, emus, llamas and alpacas.

Animal, small: Animals characterized by their relative size to other animals and including but not limited to chickens, ducks, geese, turkeys, pheasants, mink and rabbits.

Architectural value: Representing one (1) or more periods or styles of architecture typical of one (1) or more eras in the history of the county.

Attic: The unconditioned part of a building immediately below the roof situated wholly within the roof framing (see “story, half” for conditioned “attic” space).

Basement: That portion of a building that is partially or entirely below grade, that is so situated where both of the following apply:

1. The finish floor level immediately above such under-floor space shall not be more than six (6) feet above grade for more than 50 percent of the under-floor area; except that on lots where the “-n₁” combining designation applies, a basement threshold of four (4) feet (instead of six (6) feet) shall apply (see §3.40.030). Window wells, as defined and required for egress by the California Building Code (CBC) and California Residential Code (CRC), shall be limited to 10% above the minimum dimensions required by the CBC and CRC.

2. The finish floor level above such under-floor space shall not be more than 12 feet above grade at any point.

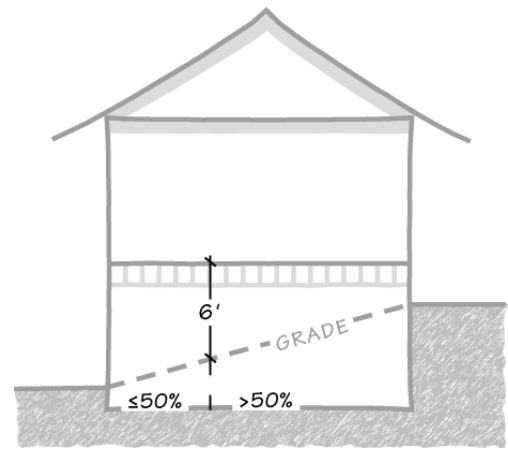

Fig. 1.30-1
Basement Threshold

For the purpose of this definition, “grade” shall be final grade at the building’s perimeter, and shall be projected through the subject basement space when appropriate.

Bay window: A window or series of windows jutting out from the wall of a building and forming an alcove within.

Boarding house: Any residential building used for the renting of rooms or providing of table board, or both, for three (3) to six (6) persons over the age of 16 years who are not related by blood or marriage to the resident-operator thereof.

Breezeway: A covered passageway open on two (2) or more sides, joining two (2) or more detached buildings.

Building: Any structure having a roof supported by columns or walls, or both, and intended for the shelter, housing or enclosure of any person, animal or personal property. When any portion of a structure is completely separated from every other portion of the structure by a masonry division or firewall without any window, door or other opening and the masonry division or

firewall extends from the ground to the upper surface of the roof at every point, such portion shall be deemed to be a separate building.

Building envelope: The three-dimensional space within which a building or structure may be built, as defined by setbacks and height regulations. Building envelopes may also be delineated for portions of lots on an approved subdivision map, cluster subdivision approval, or conditions of the subdivision or other land use approval. In such cases, the line segments delineating the building envelope shall function as setback lines for residences, and may confine the location of certain other buildings or structures if so stated on the approved map, or as a condition of subdivision approval that more specifically defines the purposes of the building envelope.

Building footprint: That portion of a property vertically below the maximum extensions of the enclosed structure(s) thereon, including covered decks, uncovered decks over 30 inches above grade, and carports, but excluding roof projections of two and one-half (2.5) feet or less.

Building, main: A building or buildings in which the lot's principal use is conducted.

Centerline: The centerline of a street as established by the County Surveyor of the County or by the city engineer of any city within the county or by the California Department of Transportation. If no such center line has been established, the center line of a street shall be a line midway between the side lines of the right-of-way thereof; provided, however, that if only a part-width right-of-way exists for any portion of any street, the center line for such part-width portion shall be determined by prolonging the center lines on each side of such part-width portion parallel to the side lines of such part-width portion. If the foregoing method of establishing the centerline is not feasible, the zoning administrator shall designate the centerline.

Development area: That portion of a property within which buildings, accessory structures, and associated improvements are proposed and delineated on site plans or subdivision maps in accordance with applicable policies of the general plan or the zoning ordinance. Associated improvements include, but are not limited to driveways, parking areas, turnarounds, septic systems, patios, pools and recreational facilities.

Dwelling purposes: The use of a building for human habitation, which is designed, intended or used for sleeping, cooking, eating, and sanitation.

Dwelling unit: A building or portion thereof that is designed, intended or used for dwelling purposes for one family, as defined in this section.

Family: One or more persons occupying a premises and living as a single, nonprofit household, as distinguished from a group occupying a hotel, club, fraternity or sorority house. A family shall be deemed to include necessary domestic help.

Fee access corridor: That portion of a flag lot used for access that is owned in fee simple.

Floor area, gross: The sum of the gross horizontal areas of the several floors of a building, as measured from the rough exterior faces of the exterior walls, or (if applicable) from the centerline of a common between two attached buildings.

“Floor area, gross” also includes the total of any attached garage, and includes any carport, porch or similar attached structure feature that is both: (a) covered, and (b) greater than 50% enclosed by perimeter walls. It includes the horizontal area of an interior stairway at each of the two or more stories to which the stairway provides access. Any attic space has a minimum clearance of seven (7) feet in each of three (3) dimensions for at least 70 contiguous square feet shall be included. Basement space that has a minimum clearance of seven (7) feet in each of three (3) dimensions for at least 70 contiguous square feet shall be included in floor area when determining: (a) required nonresidential parking spaces as stipulated in §4.30.040; (b) floor area limitations applicable to accessory dwelling units; (c) cumulative floor area that may be subject to building site approval (Ordinance Code Division C12, Chapter II); and (d) floor area that may be subject to regulations of the Department of Environmental Health, County Fire Marshal, or other government department or agency.

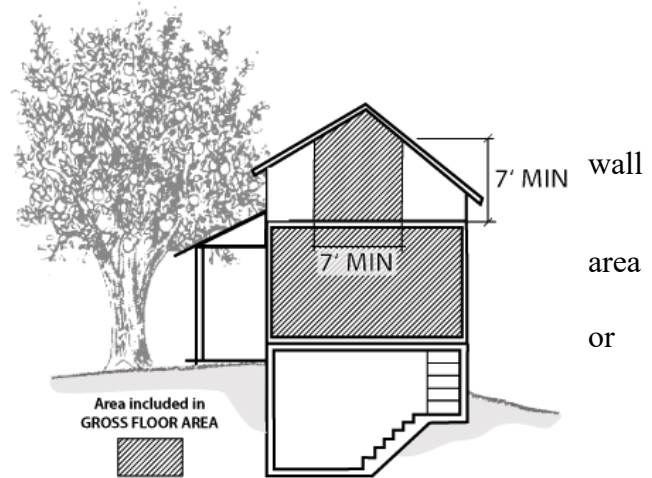

Fig. 1.30-2
Gross Floor Area that

Where the vertical distance between any floor and the ceiling above exceeds 15 feet, floor area shall be counted twice.

Except where the provisions of § 3.40.030 apply, basements shall be excluded when calculating residential floor area or floor area ratio where provisions are intended to either: (a) stipulate maximum building size, or; (b) categorize a project under the provisions of §3.20.030, 5.50.050 or 5.50.060 for procedural purposes.

Floor-area ratio (FAR):

Determined by dividing the gross floor area of a specified building(s) on a lot by the net lot area; provided, however, that on flag lots, all portions of fee access corridors which are less than 25 feet in width shall be excluded from floor area calculations.

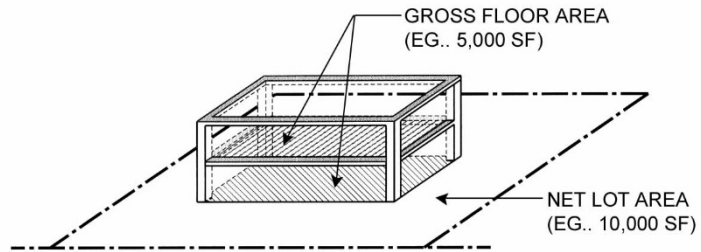

$$\text{FAR} = \frac{\text{GROSS FLOOR AREA}}{\text{NET LOT AREA}}$$

$$\text{(EG: } \frac{5,000}{10,000} = \text{FAR 0.5)}$$

Fig. 1.30-3
Floor Area Ratio

Future width line:

A line representing the maximum planned width of a right-of-way, as shown on maps included in any officially adopted report or ordinance. This includes the 1971 Ruth and Going Future Width Line Study.

Guest room: A room within a dwelling which is intended, arranged or designed to be occupied or which is occupied by one or more guests, but in which there are no cooking facilities.

Hedge: Plants that are cultivated to result in a dense linear form that functions as a fence, wall or barrier.

Height: The dimension measured by the vertical distance from the final grade to the top of a building or structure. On sloping lots or lots with irregular topography, height shall be measured vertically upward from a hypothetical surface representing the final grade as projected through the structure site (see Figure 1.30-4b for measurement details).

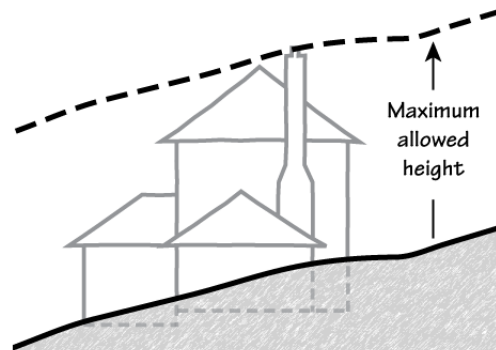
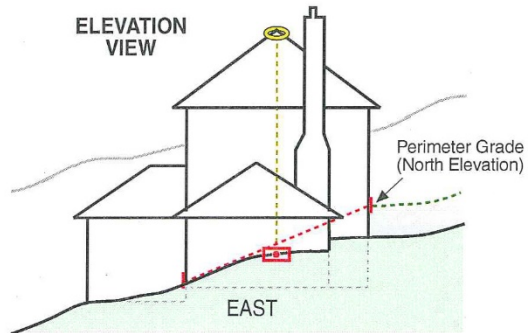
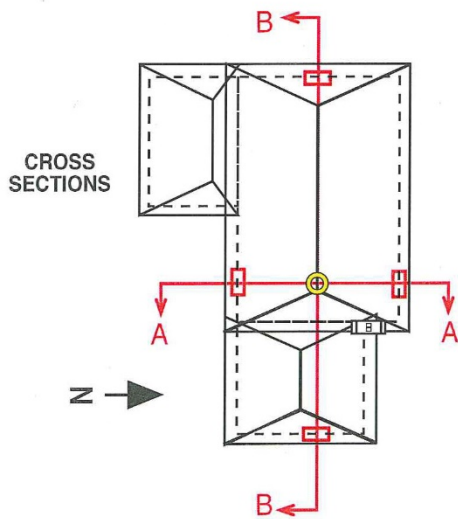
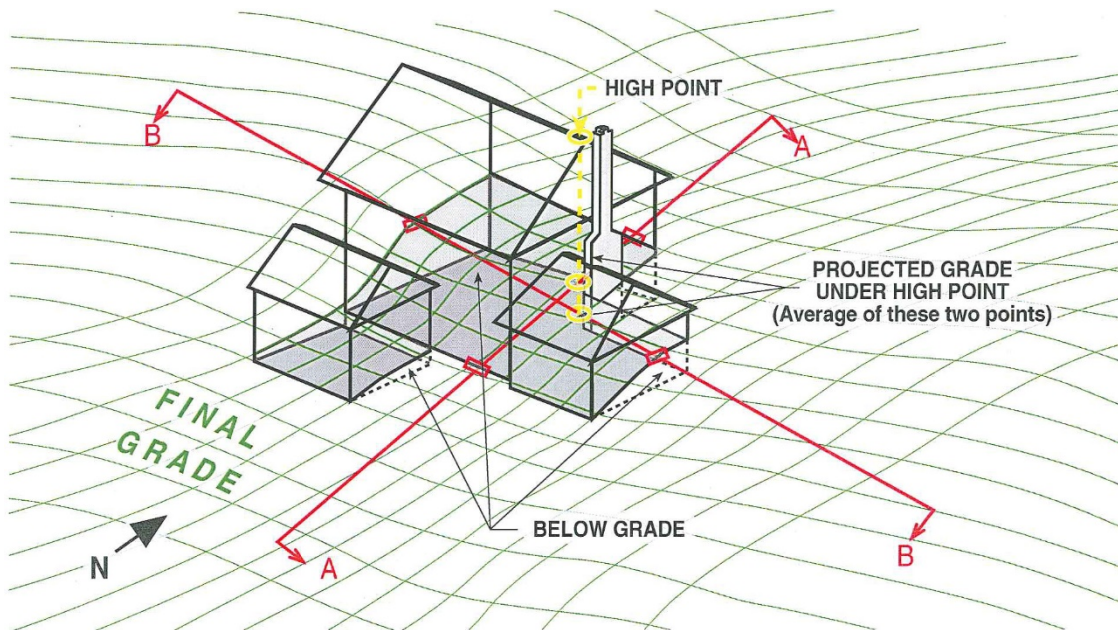

Fig. 1.30-4a
Building Height

Fig. 1.30-4b
HEIGHT MEASUREMENT
 (Irregular Topography)



Legal-nonconforming use, lot, or structure: A use, lot, building or structure that was lawful when brought into existence, but does not comply with the currently effective use provisions, permitting requirements or development standards of this zoning ordinance. See Chapter 4.50.

Livestock: Domestic animals kept on a farm or ranch and raised for sale and profit.

Lot: A fundamental unit of land that may be lawfully sold as a separate parcel in conformance with the applicable lot-legality provisions of Division C12 of the County Ordinance Code and the applicable subdivision and lot-legality provisions of state law.

Lot area, gross: The area specified as gross lot area on a recorded parcel map, tract map or record of survey. Also, the total area of any lot whose deed contains a legal description that includes land underlying public or private rights-of-way as fee-title portions of the lot.

Lot area, net: The net area of a lot specified as such on a recorded parcel map, tract map or record of survey, or the total land area of any lot exclusive of land underlying public or private rights-of-way.

Lot, corner: A lot situated at the intersection of two (2) or more streets, or bounded on two (2) or more adjacent sides by street lines. If the interior angle of the intersecting street lines is 135 degrees or wider, the lot shall not be deemed a corner lot.

Fig. 1.30-5
Classification of Lots

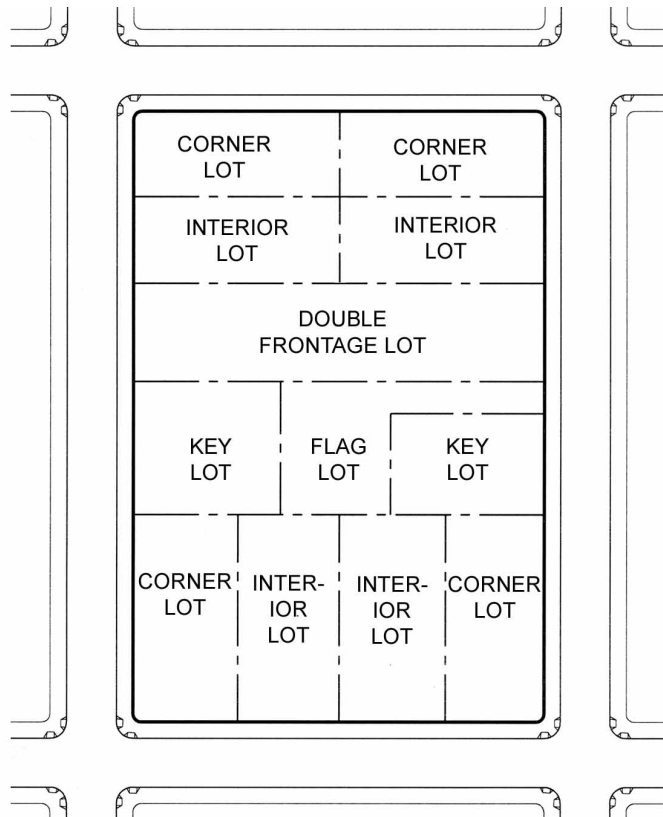

Lot coverage: The footprint of all buildings and structures over 30 inches in height. Covered patios, carports, arbors, and similar structures are counted in lot coverage. Eaves are excluded provided they do not project more than two and one-half feet.

Lot depth: The average distance from the front property line (or edge of right-of-way) to the rear line measured in the general direction of the side lines of the lot.

Lot frontage: The boundary of a dedicated public or private road right-of-way as it fronts along a lot. To determine the front lot line for setback purposes, see “lot lines.”

Lot, flag: A lot, generally located to the rear of another lot, whose frontage to a street is provided by a fee access corridor, or whose access is provided by an easement through the parcel with actual frontage along such street. [See Fig. 1.30-5]

Lot, interior: A lot with street frontage and whose side lot lines are the side lot lines of adjacent lots that front on the same street. [See Fig. 1.30-5]

Lot, key: The first lot to the rear of a corner lot, the front line of which is a continuation of the side line of the corner lot, exclusive of the width of any alley, and fronting on the street which intersects or intercepts the street on which the corner lot fronts. [See Fig. 1.30-5]

Lot lines: The lines bounding a lot as defined herein, with the following specific classifications and criteria for determining setbacks. For purposes of this definition, "street" shall mean “right-of-way,” as defined herein.

1. The **front lot line** is normally the line that abuts a street.
2. The **front lot line of a corner lot** is normally the shorter line (representing the narrower lot dimension) of the two lines abutting a street. If a corner lot's overall depth-to-width dimensions are more strongly representative of the lot's orientation such that an alternate frontage determination would yield a larger building envelope, the right-of-way line that corresponds to the lot width (longer line in that case) shall be deemed the front lot line for setback purposes. In the case of a curved corner, a determination may be made by the zoning administrator that an appropriately situated point along that curve shall demarcate the front lot line from the exterior side lot line.
3. The **front lot line of a flag lot** shall be based on the lesser dimension (width/length) of the main portion of the lot (portion that excludes access corridor). The line abutting the interior terminus of the access corridor that corresponds to that lesser lot dimension shall be deemed the front lot line. When a fee access corridor exceeds 25 feet in width, the front lot line shall be the street frontage at the access corridor. For a variable-width access corridor the front lot line shall be considered the width line at the point at which the access corridor exceeds 25 feet.
4. The **side lot line** is the line that intersects the front lot line, the rear lot line, and any other side lot line.

5. The **side exterior lot line** of a corner lot is the (generally) longer of the two lines abutting a street (see Paragraph 2 above).
6. The **rear lot line** is generally the line that is most distant and opposite the front lot line. On a triangular lot or other lot where no logical rear lot line exists, the rear setback may be taken as a radius from the point of intersection of side lines most distant and opposite the front lot line. Multiple line segments that logically fit the intent of this definition may also be considered rear lot lines.

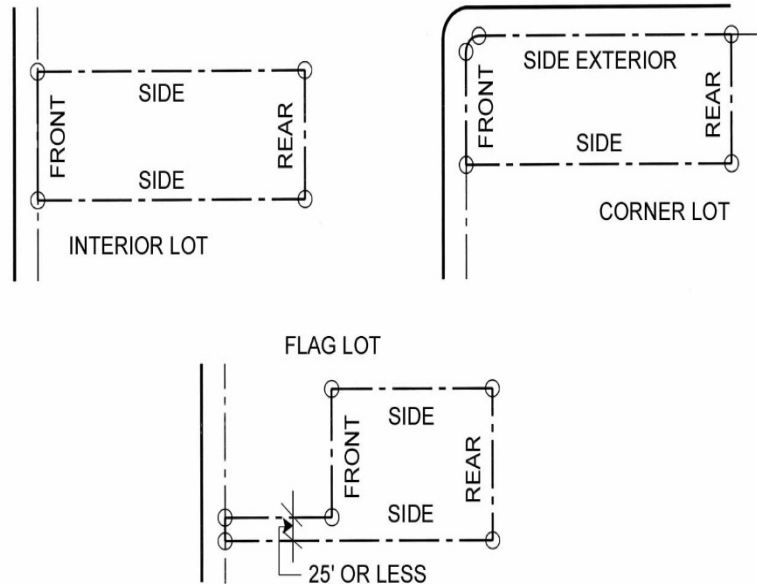
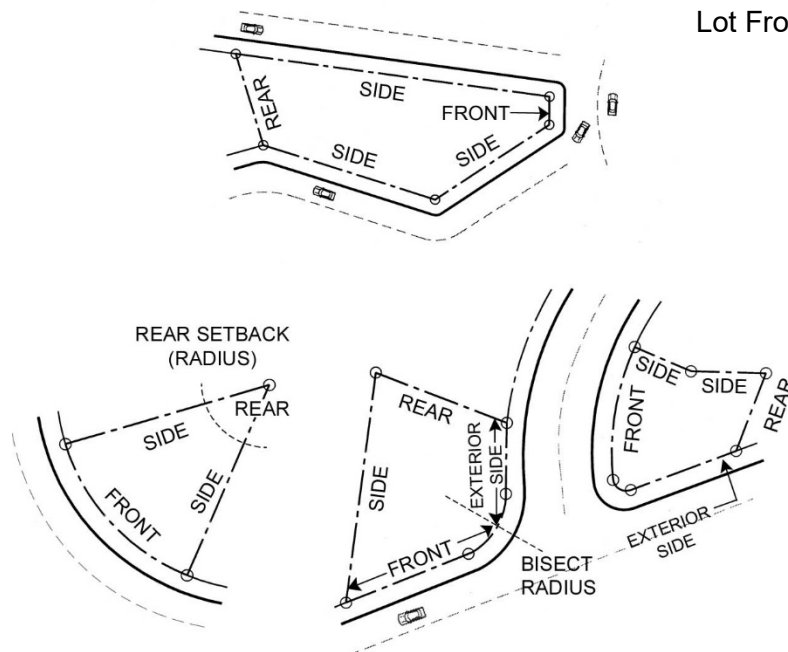

Fig. 1.30-6
Lot Lines and
Lot Frontage

Where the above provisions are inadequate to address an unusually configured lot, the zoning administrator shall classify the lot lines on that lot. The determination shall consider in the following order of importance: (a) the general depth-to-width orientation of the lot and the establishment of a practical and reasonable building envelope, (b) the orientation of the lot and orientation of the determined building envelope as it would most harmoniously concur with development and/or building envelopes on the adjacent lots, (c) the existing development on the subject lot and the degree to which it may conform to more than one possible determination, and (d) other factors specific to the lot that would affect the practicality and reasonableness of a determined building envelope. See § 4.20.020 for additional lot-line and setback criteria for accessory buildings on lots with unusual configurations.



Manufactured home: A factory-built single-family structure as defined in Section 19971 of the California Health and Safety Code or a manufactured home as defined in Section 18007 of the California Health and Safety Code. Mobilehomes, which are structures transportable in one or more sections, designed to be used as a residential dwelling unit and not having wheels or axles permanently attached to their body or frame, are considered manufactured homes if they are built in conformance with the National Manufactured Housing Construction and Safety Standards Act of 1974 (42 USC Section 5401) and located on a foundation system pursuant to Section 18551 of the California Health and Safety Code. Manufactured homes or mobilehomes do not include recreational vehicles, or commercial coaches, as defined in Section 19971 of the California Health and Safety Code.

Marginal agricultural lands: Lands that may be considered unsuitable for agricultural use because of proximity to incompatible non-agricultural uses, inadequate water availability; or marginal soil type such as Class III or poorer.

Mine, idle: A mining operation that is curtailed for one (1) or more year(s) by more than 90 percent of the operation's previous maximum annual mineral production, with the intent to resume those surface mining operations at a future date.

Mobilehome: See "manufactured home."

Movable tiny home: A structure on wheels used for dwelling purposes that provides complete independent living facilities for one or more persons and is located on the same lot as the primary dwelling (single-family or multifamily) to which it is an accessory use. It includes permanent provisions for living, sleeping, eating, cooking, and sanitation on the same parcel as the primary dwelling to which it is accessory. It complies with all State of California requirements, is constructed in compliance with American National Standards Institute (ANSI) 119.5 standard, cannot move under its own power, is licensed and registered with the California Department of Motor Vehicles, is no larger than allowed by state law for movement on public highways, and has at least 100 square feet of enclosed space (see Sections 2.10.020 and 4.10.015).

Nonconforming use, lot, or structure: The term "nonconforming" shall mean legal-nonconforming. See "legal-nonconforming use, lot or structure."

Official plan line: A line representing the maximum planned width of a right-of-way, including future right-of-way, as defined in Section C12-700 of the County Ordinance Code.

Open land historic: The unimproved or undeveloped portion of the land on which the historic buildings or structures exist and which is essential to the integrity of the historical site or place.

Open space land: Any parcel(s) or portion of a parcel that is essentially unimproved and devoted to an open space use. This term includes land(s) designated for permanent open space preservation as shown on a recorded subdivision map, approved site plan, or other development plan, and which may be the subject of an easement or other permanent conveyance of

development rights restricting the use and development potential of the open space in accordance with applicable general plan policies, zoning regulations, mitigations, or conditions of approval.

Person: Any individual, firm, association, corporation, organization or partnership, or any city, county, district or state, or any public entity or department or agency thereof.

Public water supply: Water service furnished by a public utility, a county water company or district, a municipal water company or district, a community service district or other public water district.

Reclamation: The combined process of land treatment that minimizes water degradation, air pollution, damage to aquatic or wildlife habitat, flooding, erosion, and other adverse effects from surface mining uses so that mined lands are reclaimed to a usable condition which is readily adaptable for alternate land uses and pose no danger to public health or safety. The process may extend to affected lands surrounding mined lands, and may require backfilling, grading, re-soiling, re-vegetation, soil compaction, stabilization, or other measures.

Reclamation plan: A plan providing for reclamation of lands upon which surface mining operations either have been or will be conducted.

Registered historic cultural resource: A registered historic cultural resource is any building, site, structure, object, or district which is registered in the National Register of Historic Places, California Historical Landmarks Program, California Register of Historical Resources, California Points of Historical Interest Program, or formally designated as such by a resolution of the Santa Clara County Board of Supervisors.

Right-of-way: The total (improved and unimproved) area of land within the bounds of a dedicated public or private road. Also includes any ingress-egress easement that provides the right to pass over one property to access another.

Riparian: That area within and adjacent to waterways, water bodies and areas with special underground wetness characteristics which support a special type or lush condition of vegetation not found in the general area.

Sanitary sewers: Sanitary sewers shall mean those sewer systems operated and maintained by a county, a municipality, or a sanitary sewer district.

Sanitation facilities: Sanitation facilities shall mean a toilet, sink, and bathing facilities (tub or shower) serving a dwelling unit that comply with all requirements of state law and the Ordinance Code.

Setback: The horizontal separation required between lot lines (and/or rights-of-way, see below), and the nearest point of a building or structure, including below-grade walls. The setback line shall be deemed to mean a line parallel to the lot line separated by the required setback distance.

The measurement shall be taken from the rough exterior building walls (structural wall components; excluding trim, exterior siding, stucco or other such finishing materials), or other vertical structural components, to the nearest lot line, exclusive of those architectural features listed in Section 4.20.110 as exempt. Setbacks shall also be taken from the edge of any right-of-way that abuts or passes through the subject lot. In situations where the property line lies within the right-of-way, the setback shall be taken from the edge of such right-of-way. However, if an official plan line or future width line has been established for the abutting right-of-way, setback measurement shall be taken from such official plan line or future width line.

Story: That portion of a building included between the upper surface of any floor and the upper surface of the floor above, except that the topmost story shall be that portion of a building included between the upper surface of the topmost floor and the ceiling or roof above.

An attic, regardless of its interior dimensions, shall not be considered a story provided it remains unconditioned space, is accessible by nothing more substantial than a pull-down stairway or ladder, and contains no dormers with the exception of minimal vent features.

A basement shall not be considered a story.

Determination of a building's number of stories shall be based on qualifying floor area being situated directly above other qualifying floor area.

Story, half: A portion of a building within a hip, gable or similar sloping roof containing space that meets the dimensional criteria for habitable space (70 square feet or larger with a minimum seven (7) feet clearance in each of three (3) dimensions), but is limited such that the wall plates on at least two (2) opposite exterior (vertical) walls, which constitute at least 50 percent of the perimeter wall area at that floor level, are not more than two (2) feet above rough floor level.

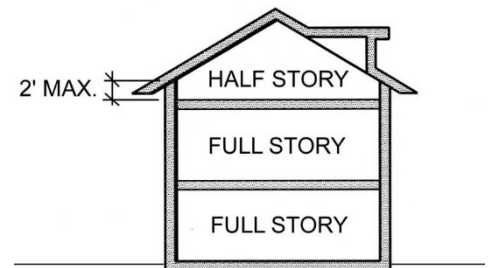

Fig. 1.30-7
Half Story

Structural alterations: Any change in the supporting members of a building, such as bearing walls, foundation, roof, columns, beams or girders.

Structure: Anything constructed or erected, the use of which requires location on the ground or attachment to something having location on the ground. The term “structure” includes “building.”

Urban service area: Land within the sphere of influence of a particular city, which is served by urban facilities, utilities and services, or which is proposed to be served by urban facilities, utilities and services through a city-adopted capital improvement program. In addition to being regulated by the County zoning ordinance, unincorporated land within a city's urban service area

is subject to the land use policies of that city's general plan. The urban service area boundary shall be established by the Santa Clara County Local Agency Formation Commission in accordance with the applicable provisions of Sections 56300, 56301 and 56425 of the California Government Code.

Use: The purpose for which land or premises or a building thereon is designed, arranged or intended or for which it is or may be occupied or maintained. When used as a verb, standard dictionary definitions of "use" shall apply.

Watercourse: A running stream fed from permanent or natural sources, including rivers, creeks, runs and rivulets. There must be a stream, usually flowing in a particular direction (though it need not flow continuously) in a definite channel, having a bed or banks and usually discharging into some stream or body of water.

Yard: An open space, adjacent to a dwelling or other main building, that is generally unoccupied and unobstructed from the ground upward, except as otherwise provided in Chapter 4.20. The following are types of yards:

1. The front yard extends across the full width of the lot lying between the front lot line and the nearest line of the dwelling.
2. The side yard lies between the side lot line and the side wall(s) of the dwelling and extends from the front yard to the rear yard.
3. The rear yard extends across the full width of the lot lying between the rear lot line and the nearest line of the primary dwelling.

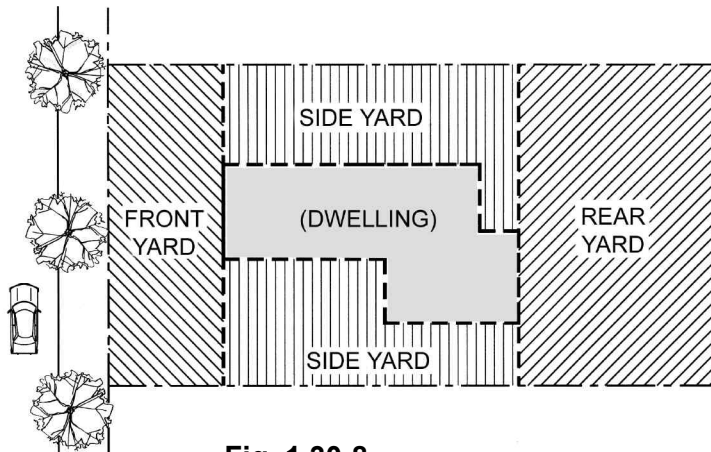

Fig. 1.30-8

SECTION 2. Section 2.10.030 of Chapter 2.10, Article 2 of Appendix I, Zoning, of the County of Santa Clara Ordinance Code, is amended as follows:

§ 2.10.030 Residential Use Classifications

Residences. This classification includes primary residences and excludes other types of residences separately defined within this section. This classification also includes the renting of rooms and provision of meals within a dwelling by the resident family or household to not more than two other individuals (for rooming houses, see *Rooming Houses, Fraternities & Sororities*).

It also includes employee housing that provides exclusive accommodation for six (6) or fewer employees, pursuant to California Health and Safety Code-Section 17021.5, and emergency, supportive, and transitional housing for six (6) or fewer clients.

All uses within this classification shall fit within one of the following subcategories:

1. **Single-Family.** One dwelling unit on a single lot, completely detached from any other dwelling unit. This classification includes a manufactured home.
2. **Two-Family.** Two dwelling units within the same structure, each having its own kitchen and bathroom facilities.
3. **Multi-Family.** Three or more dwelling units within the same structure, each having its own kitchen and bathroom facilities.

Residential Accessory Structures and Uses. This classification includes detached buildings and structures whose use is entirely incidental to the primary residential use, and which do not contain living space or sleeping quarters. Residential accessory uses consist of activities customarily associated with (or otherwise reasonably associated with) the primary residential use, and include such activities when they occur on private communal open space within a residential development. Private, noncommercial gatherings hosted by residents or property owner(s) shall be considered residential accessory uses.

On lots with no legally established residential use, certain limited structures ancillary to maintenance and security of the land (e.g. fences, gates, well or irrigation hardware) shall be considered permitted accessory structures under this classification.

On lots with no legally established residential use, one limited storage building per lot is permitted under this classification in rural base zoning districts. The floor area of such storage buildings is restricted to 120 square feet maximum. Height shall not exceed 10 feet in height at any point, and such buildings shall comply with all other applicable provisions of Section 4.20.020. Such storage buildings may not include plumbing or electricity in their construction. Any such building in an –sr combining district shall be subject to the scenic roads provisions of Section 3.30.030.

Accessory buildings shall be limited to two (2) internal plumbing fixtures except as provided by subsection 4.20.020(I).

Accessory dwelling unit–ADU: A residential dwelling unit that provides independent living facilities and is located on the same lot as the primary dwelling (single-family or multifamily) to which it is an accessory use. It includes permanent provisions for living, sleeping, eating, cooking, and sanitation on the same parcel as the primary dwelling to which it is accessory. Accessory dwelling units include standard ADUs, movable tiny homes, and Junior ADUs. ADUs include an efficiency unit as defined in Health and Safety Code section 17958.1, and a manufactured home as defined in Health and Safety Code section 18007. This use classification is intended to be consistent with Government Code section 65852.2 and all other state laws as

those laws are amended from time to time. If there is any conflict between this use classification and state law, state law shall prevail. [Criteria/Findings § 4.10.015]

1. **Standard ADU.** A standard accessory dwelling unit that provides complete independent living facilities. It includes permanent provisions for living, sleeping, eating, cooking, and sanitation. It may be attached or detached. [Criteria/Findings § 4.10.015]
2. **Movable Tiny Home.** A detached structure on wheels used for dwelling purposes that provides complete independent living facilities for one or more persons and is located on the same lot as the primary dwelling (single-family or multifamily) to which it is an accessory use. See Section 1.30.030 “Movable tiny home.”
3. **Junior ADU.** A dwelling unit that is no more than 500 square feet in size, and is contained entirely within a primary single-family residence or a detached accessory dwelling unit, and both shall have independent entrances. It includes permanent provisions for living, sleeping, eating, cooking, and sanitation facilities on the same parcel as the primary dwelling to which it is accessory. A junior accessory dwelling unit may include separate sanitation facilities, or may share sanitation facilities with the existing dwelling unit. The junior accessory dwelling unit must contain either a full kitchen or an efficiency kitchen consisting of cooking facilities with appliances, food preparation counters, and storage cabinets that are of reasonable size in relation to the junior accessory dwelling unit. This use classification is intended to be consistent with Government Code sections 65852.2 and 65852.22 and all other state laws as those laws are amended from time to time. If there is any conflict between this use classification and state law, state law shall prevail. [Criteria/Findings § 4.10.015]

Agricultural Employee Housing. Dwellings occupied by employees engaged primarily in direct agricultural operations on land owned or rented by the agricultural operator. Family members of such agricultural employees may also live in the same unit. All uses within this classification shall fit within one of the following subcategories:

1. **Short Term.** One or more mobile homes or manufactured homes located on land in agricultural use. A time limit for use of short-term agricultural worker housing will be specified on a case-by-case basis at the time of permit issuance. [Criteria/Findings § 4.10.040]
2. **Long Term.** Permanent structures located on land owned by an agricultural operator used by agricultural workers employed by such operator and the families of the workers. [Criteria/Findings § 4.10.040]

Caretaker’s Residences. Dwelling units incidental and subordinate to a significant nonresidential use established by issuance of a use permit. Such units must be necessary for the practical operation of the primary use, and the occupancy of such units shall be limited to owners or employees of the primary use and their families.

Domestic Animals. The keeping of domesticated animals for use or enjoyment within the home or premises by the resident occupants, including non-commercial equestrian activities. All uses within this classification shall fit within one of the following subcategories:

1. **Dogs & Cats.** The keeping of dogs and cats.
2. **Small Animals–Limited.** Includes the following small animals: rabbits, guinea pigs, chicken and fowl (but excluding roosters, peafowl, guinea fowl, geese or quacking ducks), and similar species as approved by the zoning administrator.
3. **Horses.** The keeping of horses.

Home Occupations. Businesses conducted incidental to the residential use of a property, generally within a dwelling by resident occupants. All uses within this classification shall fit within one of the following subcategories:

1. **General.** Uses conducted exclusively within the dwelling by the resident, with allowance for one (1) nonresident employee. [Criteria/Findings § 4.10.180]
2. **Expanded.** Uses conducted in the dwelling or accessory building by the resident, with allowance for one (1) nonresident employee, limited outdoor storage of materials, and not more than two vehicles. [Criteria/Findings § 4.10.180]

Residential–Communal Institutional. A facility containing rooms or apartments (or both) but having communal dining facilities and lounges, and communal services, such as housekeeping, organized social and recreational activities, and support services appropriate for the residents. Includes college dormitories, monasteries and other such communal living facilities related to permitted institutional use classifications. Excludes nursing homes and similar uses (see *Community Care Facilities*). Also excludes rooming houses (see *Rooming Houses, Fraternities & Sororities*). [Criteria/Findings § 4.10.300]

Rooming Houses, Fraternities & Sororities. Includes fraternity and sorority housing for students, boarding houses, and similar group residential uses. Also includes single-room occupancy residential facilities where secure rooms are individually rented to a one- or two-person household. Excludes those uses classified as *Residential–Communal Institutional*.

Temporary Residences during House Construction. Mobile homes, recreational vehicles, or existing homes occupied during the construction, repair, or remodel of a permanent dwelling on the same property. The temporary residence may remain on the property for no longer than 90 days from the date of occupancy of the permanent dwelling, or for two years from the date of either initial building permit issuance or the date of any casualty that rendered the primary residence uninhabitable, whichever occurs first. The provisions of subsection 4.20.090(B) shall apply to emergency housing following casualty. [Criteria/Findings § 4.10.380]

SECTION 3. Section 2.20.020 of Chapter 2.20, Article 2 of Appendix I, Zoning, of the County of Santa Clara Ordinance Code, is amended as follows:

§ 2.20.020 Use Regulations

The following tables, Tables 2.20-1 and 2.20-2, specify the allowable land uses for the rural base districts, listed by use classification as defined in Chapter 2.10. The regulations for each district are established by letter designations as follows:

- “R” designates use classifications that are permitted by right. The term “by right” indicates no discretionary permit process by the Planning Office is required. Compliance with zoning standards will be confirmed during the building permit process, where applicable. See subsection 1.20.040(D) for applicability of other rules and processes.
- “C” designates use classifications that require an administrative planning clearance from the Planning Office. Planning clearances are for uses that require adherence to the Zoning Ordinance but for which no discretionary permit from the Planning Office is required.
- “S” designates use classifications permitted with a special permit, subject to the provisions of Chapter 5.60, Special Permit.
- “A” designates use classifications permitted with architecture and site approval, subject to the provisions of Chapter 5.40, Architecture and Site Approval.
- “U” designates use classifications permitted with a use permit and architecture and site approval, subject to the provisions of Chapter 5.65, Use Permit, and Chapter 5.40, Architecture and Site Approval.
- “–” designates use classifications that are not allowed.

Supplemental regulations for the establishment and conduct of a use are referenced in the “Supplemental Regulations” column of the tables. Use classifications not listed in the tables are prohibited in the rural base districts.

USE CLASSIFICATIONS	ZONING				Supplemental Regulations
	A	AR	HS	RR	
Residences: Single-Family	R	R	R	R	Note 1

- R** Permitted by Right
- C** Planning Clearance
- S** Special Permit (Ch 5.60)
- A** ASA (Ch 5.40)
- U** Use Permit/ ASA (Ch 5.65, 5.40)
- Not Permitted

Table 2.20-1

**RESIDENTIAL USES
IN RURAL BASE DISTRICTS**

- R** Permitted by Right
- C** Planning Clearance
- S** Special Permit (Ch 5.60)
- A** ASA (Ch 5.40)
- U** Use Permit/ ASA (Ch 5.65, 5.40)
- Not Permitted

USE CLASSIFICATIONS	ZONING				Supplemental Regulations
	A	AR	HS	RR	
Residential Accessory Structures & Uses	R	R	R	R	§ 4.20.020
Accessory Dwelling Units					
Standard ADUs	R	R	R	R	§ 4.10.015
Movable tiny homes	C	C	C	C	§ 4.10.015
Junior ADUs	R	R	R	R	§ 4.10.015, Note 9
Agricultural Employee Housing					
Short Term	S	S	S	S	§ 4.10.040, Note 2
Long Term	U	R	U	U	§ 4.10.040, Note 2, Note 3 (AR)
Community Care					
Limited	R	R	R	R	§ 4.10.090, Note 4
Expanded	U	U	U	U	§ 4.10.090, Note 5
Domestic Animals					
Dogs & Cats	R	R	R	R	Note 6
Other (see Ag: Livestock, Table 2.20-2)					
Home Occupations					
General	R	R	R	R	§ 4.10.180
Expanded	S	S	S	S	§ 4.10.180, Note 7
Residential – Communal Institutional	U	U	U	U	§ 4.10.300, Note 8
Temporary Residences / Construction	R	R	R	R	§ 4.10.380

NOTES:

1. Single-family dwellings, including certain additions, may be subject to the building site approval provisions of Section C12-300 et seq. of the County Ordinance Code.
2. Agricultural employee housing units may, on a limited basis, be used to accommodate overnight tourist stays. See subsection 4.10.395(H)(2) for criteria and permitting requirements.
3. On lots 10 acres or larger in AR districts, a second one-family dwelling for agricultural employee housing is allowed by right. Such agricultural employee housing unit shall not be subject to the supplemental use regulations of § 4.10.040.
4. Facilities qualifying as “Large-Family Day-Care Homes,” serving between 7 and 14 children, are subject to an administrative permit, per the provisions of Division B24 of the County Ordinance Code.

5. Not a permitted use in areas with the “Agriculture-Large Scale” land use plan designation of the general plan.
6. Not to exceed two (2) dogs and five (5) cats over four months of age on parcels less than five acres, or three (3) dogs and five (5) cats over four months of age on parcels five acres or more, unless the required permit is secured pursuant to Division B31 of the Ordinance Code.
7. Expanded home occupations permitted on lots one-acre or larger. For additional applicable criteria, see § 4.10.180.
8. In rural districts, the floor area of Residential – Communal Institutional uses shall be limited to 10,000 square feet or less.
9. Owner-occupancy of one unit is required in any single-family residence that contains a junior accessory dwelling unit. The owner may reside in either the single-family residence or the junior accessory dwelling unit. Owner-occupancy shall not be required if the owner is a governmental agency, land trust, or housing organization.

Table 2.20-2

**NON-RESIDENTIAL USES
IN RURAL BASE DISTRICTS**

- R** Permitted by Right
- C** Planning Clearance
- S** Special Permit (Ch 5.60)
- A** ASA (Ch 5.40)
- U** Use Permit/ ASA (Ch 5.65, 5.40)
- Not Permitted

USE CLASSIFICATIONS	ZONING				Supplemental Regulations
	A	AR	HS	RR	
Agriculture					
General	R	R	R	R	
Livestock	R	R	R	R	Note 1 (HS)
Agricultural Accessory Structures/ Uses	R	R	R	R	§ 4.20.020
Agricultural Equipment Sales/ Services	A	–	–	–	
Agricultural Processing					
Small Scale	R	R	R	R	§ 4.10.030
Medium Scale	A	–	–	–	§ 4.10.030
Large Scale	U	–	–	–	§ 4.10.030
Agricultural Research	A	–	–	–	
Agricultural Sales					
Limited	R	R	R	R	§ 4.40.110 (Signs)
Farmers’ Markets	U	U	–	–	
Agriculturally Related Entertainment & Commercial Uses	U	–	–	–	§ 4.10.050
Aircraft Landing Strips – Private	U	U	–	–	Note 2
Antennas – Commercial					

Table 2.20-2

**NON-RESIDENTIAL USES
IN RURAL BASE DISTRICTS**

R Permitted by Right
C Planning Clearance
S Special Permit (Ch 5.60)
A ASA (Ch 5.40)
U Use Permit/ ASA (Ch 5.65, 5.40)
- Not Permitted

USE CLASSIFICATIONS	ZONING				Supplemental Regulations
	A	AR	HS	RR	
Minor	A	A	A	A	
Major	U	U	U	U	
Bed & Breakfast Inns	U	U	U	U	§ 4.10.060, Note 3
Butcheries	U	U	-	-	
Camps & Retreats	U	U	U	U	§ 4.10.070, Note 4
Cemeteries	U	U	U	U	§ 4.10.080, Note 4
Churches [See “Religious Institutions”]					
Clubs–Private & Nonprofit	U	U	U	U	§ 2.20.090
Community Care					
Limited	R	R	R	R	§ 4.10.090, Note 6
Expanded	U	U	U	U	§ 4.10.090, Note 4
Dairies	U	U	-	-	§ 4.10.110
Entertainment– Seasonal Outdoor	-	-	U	-	§ 4.10.120
Emergency Shelters					
Small-Scale	-	-	-	R	§ 4.10.115
Large-Scale	-	-	-	U	§ 4.10.115, Note 20
Feed Lots	U	U	-	-	§ 4.10.130
Golf Courses & Country Clubs	U	-	U	U	§ 4.10.140, Note 4
Golf Driving Ranges	U	-	-	U	§ 4.10.150, Note 4
Helipads	-	-	U	-	§ 4.10.160
Historic Structures– Use Conversion	A	A	A	A	§ 4.10.170
Hospitals & Clinics	U	U	U	U	§ 2.20.090 (AR, HS, RR Districts), § 4.10.190 (A Districts), Note 4
Hunting & Fishing Preserves	U	R	-	-	Note 7
Informational Displays					
Small	R	-	-	-	
Large	U	-	-	-	
Kennels– Commercial	U	U	U	U	§ 4.10.200

Table 2.20-2

**NON-RESIDENTIAL USES
IN RURAL BASE DISTRICTS**

R Permitted by Right
C Planning Clearance
S Special Permit (Ch 5.60)
A ASA (Ch 5.40)
U Use Permit/ ASA (Ch 5.65, 5.40)
- Not Permitted

USE CLASSIFICATIONS	ZONING				Supplemental Regulations
	A	AR	HS	RR	
Laboratories and Testing Services (Limited)	U	-	-	-	
Livestock Auction Yards	U	U	-	-	§ 4.10.210
Manufacturing: Small Scale Rural	A	U	-	-	§ 2.20.090
Museums	U	U	U	U	Note 8
Mushroom Farms	U	U	-	U	§ 4.10.220
Nonprofit Institutions	U	U	U	U	§ 2.20.090 (AR, HS, RR Districts), § 4.10.230 (A Districts), Notes 4 & 19
Nurseries					
Retail	U	U	U	U	Note 9
Wholesale	R	R	R	U	Note 9
Offices (Limited)	U	-	-	-	Note 10
Oil & Gas Extraction	U	U	U	U	
Poultry and Egg Farms–Commercial	U	U	-	U	§ 4.10.240
Radio-Controlled Model Aircraft Facilities	U	-	-	-	§ 4.10.250
Reception Facilities	U	U	U	U	§ 4.10.260
Recreational Playgrounds & Sports Fields	U	U	U	U	§ 4.10.270 (A Zoning District)
Recreational Vehicle Parks	-	-	U	U	§ 4.10.280
Recycling Facilities					
Collection Facilities–Consumer Recycling	R	R	R	R	§ 4.10.285
Recycling/ Processing Facilities–Consumer Waste	-	-	-	-	
Concrete, Asphalt & Soil Recycling	U	U	U	U	Note 11
Composting & Wood Recycling	U	U	U	U	
Hazardous Materials	-	-	-	-	

Table 2.20-2

**NON-RESIDENTIAL USES
IN RURAL BASE DISTRICTS**

R Permitted by Right
C Planning Clearance
S Special Permit (Ch 5.60)
A ASA (Ch 5.40)
U Use Permit/ ASA (Ch 5.65, 5.40)
- Not Permitted

USE CLASSIFICATIONS	ZONING				Supplemental Regulations
	A	AR	HS	RR	
Religious Institutions	U	U	U	U	§ 2.20.090 (AR, HS, RR Districts), § 4.10.290 (A Districts), Notes 4 & 19
Restaurants & Bars					
Limited-Service Eating Places	-	U	U	-	Note 12
Full-Service Eating Places	-	U	U	-	Note 12
Drinking Places	-	U	U	-	Note 12
Retail Sales & Services: Local-Serving	-	U	U	-	§ 4.10.310
Rodeos and Equestrian Event Facilities	U	U	-	-	§ 4.10.320
Schools	U	U	U	U	§ 2.20.090 (AR, HS, RR Districts), § 4.10.330 (A Districts), Note 4
Solar Energy Conversion Systems – Commercial					
Minor	A	U	U	A	§ 4.10.345, Notes 4 & 13
Major	U	U	U	U	§ 4.10.345, Notes 4 & 13
Sport Shooting	-	U	U	-	§ 4.10.350
Stables – Commercial	U	U	U	U	§ 4.10.360
Surface Mining	U	U	U	U	§ 4.10.370
Swim & Tennis Clubs	-	-	U	U	
Timber Harvest – Commercial	-	U	U	-	Note 14
Truck Sales & Services: Storage (Limited)	U	-	-	-	Note 15
Underground Mining	U	U	U	U	
Utilities and Public Facilities					Note 16
Minor	A	A	A	A	
Major	U	U	U	U	
Veterinary Clinics & Hospitals	U	U	U	U	Note 17
Well-Drilling Operations	A	-	-	-	

Table 2.20-2

**NON-RESIDENTIAL USES
IN RURAL BASE DISTRICTS**

- R** Permitted by Right
- C** Planning Clearance
- S** Special Permit (Ch 5.60)
- A** ASA (Ch 5.40)
- U** Use Permit/ ASA (Ch 5.65, 5.40)
- Not Permitted

USE CLASSIFICATIONS	ZONING				Supplemental Regulations
	A	AR	HS	RR	
Wind Energy Conversion Systems – Commercial	U	U	U	U	§ 4.10.390
Wineries					
Small-Scale	R	R	R	R	§ 4.10.395, § 4.40.110 (Signs)
Medium-Scale	S	S	S	S	§ 4.10.395, § 4.40.110
Large-Scale	U	U	U	U	§ 4.10.395, § 4.40.110
Wireless Telecommunication Facilities					Note 5
Collocation/Modification – Minor	R	R	R	R	
Collocation/Modification – Major	A	A	A	A	§ 4.10.400
New Facilities	A	A	A	A	§ 4.10.400

NOTES:

1. Livestock breeding, raising and keeping is limited in HS districts as follows: Not more than three (3) large animals or six (6) medium animals per acre as a matter of right, or a proportional combination totaling three (3) animal units where each large animal constitutes one (1) animal unit, and each medium animal constitutes 0.5 animal unit. Special permit required for numbers of large and medium animals exceeding these limits. There are no specified numerical limits for small animals.
2. Landing strip, including approach and departure zones, shall be located a safe distance from residential development to prevent significant hazard.
3. Bed and breakfast inns ancillary to on-site wineries, agricultural sales operations or other agriculturally related uses shall be subject to a special permit, in lieu of a use permit, provided they are situated within the primary residence on the property. Bed and breakfast inns are prohibited within the Los Gatos Hillside Specific Plan area, except as provided under the classification Historic Structures–Use Conversion.
4. Not a permitted use in areas with the “Agriculture-Large Scale” land use plan designation of the general plan.
5. Wireless telecommunications facilities are exempt from the development standards listed in Table 2.20-3.
6. Facilities qualifying as “Large-Family Day-Care Homes,” serving between 7 and 14 children, are subject to an administrative permit, per the provisions of Division B24 of the County Ordinance Code.
7. The minimum lot size for hunting preserves shall be one hundred sixty (160) acres.
8. Museums in rural districts shall be limited in scale and must relate to the locally significant cultural, historical or social themes of the rural area.

9. The size of buildings for on-site sales and ancillary office associated with nurseries shall be kept to a minimum.
10. Offices ancillary to a permitted agricultural activity in A districts that contain no more than 2,400 square feet of floor area are allowed as a matter of right. Offices larger than 2,400 square feet are subject to a use permit.
11. Concrete, asphalt and soil recycling within rural districts is a permitted use only in association with an existing quarry operation in any rural base zoning district.
12. Restaurants and bars in rural districts shall be limited in scale, with a maximum publically accessible floor area of 1,200 square feet (measured from outer surfaces of enclosing walls, includes bathrooms).
13. Not a permitted use in areas with the –d1 (Santa Clara Valley Viewshed) or –d2 (Milpitas Hillsides) Design Review combining zoning districts.
14. Timber harvest of commercial tree species as defined by the County Tree Preservation and Removal Ordinance, Division C16 of the County Ordinance Code, including but not limited to Redwood and Douglas Fir, may be subject to the regulatory and permitting authority of the California Department of Forestry and Fire Protection (CDF). No County permit shall be required if CDF has approved a *Timber Harvest Plan* or *Non-Industrial Timber Management Plan* for the activity.
15. Truck storage uses in rural districts shall be limited to agriculture-related tractors, trucks, trailers, and similar equipment.
16. Utility structures and facilities may be exempt from local zoning regulations if they are established by a government agency. There may also be federal or state laws that provide exemptions for certain types of utilities.
17. The minimum lot size for veterinary clinics and hospitals shall be two and one-half (2.50) acres.
18. Wireless telecommunications facilities are exempt from the development standards listed in Table 2.20-3.
19. Established *Religious Institutions* and *Nonprofit Institutions* may include *Emergency Shelters: Small-Scale* as an ancillary use by right.
20. Emergency Shelters are a permitted use only within the –sm San Martin Use Permit Areas Combining District, as depicted in Chapter 3.90 of the Zoning Ordinance.

SECTION 4. Section 2.30.020 of Chapter 2.30, Article 2 of Appendix I, Zoning, of the County of Santa Clara Ordinance Code, is amended as follows:

§ 2.30.020 Use Regulations

The following tables, Tables 2.30-1 and 2.30-2, specify the allowable land uses for the urban residential base districts, listed by use classification as defined in Chapter 2.10. The regulations for each district are established by letter designations as follows:

“R” designates use classifications that are permitted by right. The term “by right” indicates no discretionary permit process by the Planning Office is required. Compliance with zoning standards will be confirmed during the building permit process, where applicable. See subsection 1.20.040(D) for applicability of other rules and processes.

- “C” designates use classifications that require an administrative planning clearance from the Planning Office. Planning clearances are for uses that require adherence to the Zoning Ordinance but for which no discretionary permit from the Planning Office is required.
- “S” designates use classifications permitted with a special permit, subject to the provisions of Chapter 5.60, Special Permit.
- “A” designates use classifications permitted with architecture and site approval, subject to the provisions of Chapter 5.40, Architecture and Site Approval.
- “U” designates use classifications permitted with a use permit, and architecture and site approval, subject to the provisions of Chapter 5.65, Use Permit, and Chapter 5.40, Architecture and Site Approval.
- “–” designates use classifications that are not allowed.

Supplemental regulations for the establishment and conduct of a use are referenced in the “Supplemental Regulations” column of the table. Use classifications not listed in the table are prohibited in the urban residential base districts.

Table 2.30-1

**RESIDENTIAL USES
IN URBAN RESIDENTIAL BASE DISTRICTS**

- R** Permitted by Right
- C** Planning Clearance
- S** Special Permit (Ch 5.60)
- A** ASA (Ch 5.40)
- U** Use Permit/ ASA (Ch 5.65, 5.40)
- Not Permitted

USE CLASSIFICATIONS	ZONING							Supplemental Regulations
	R1	R1E	RHS	R1S	R3S	R2	R3	
Residences								
Single-Family	R	R	R	R	A	R	R	Note 1, 2 (R1S)
Two-Family	–	–	–	R	A	R	R	Note 1, 2 (R1S)
Multi-Family	–	–	–	A	A	–	A	
Residential Accessory Structures & Uses	R	R	R	R	R	R	R	§ 4.20.020 Note 3 (R3S)
Accessory Dwelling Units								
Standard ADUs	R	R	R	R	R	R	R	§ 4.10.015
Movable tiny homes	C	C	C	C	C	C	C	§ 4.10.015
Junior ADUs	R	R	R	R	R	R	R	§ 4.10.015, Note 9
Community Care								

Table 2.30-1

**RESIDENTIAL USES
IN URBAN RESIDENTIAL BASE DISTRICTS**

R Permitted by Right
C Planning Clearance
S Special Permit (Ch 5.60)
A ASA (Ch 5.40)
U Use Permit/ ASA (Ch 5.65, 5.40)
- Not Permitted

USE CLASSIFICATIONS	ZONING							Supplemental Regulations
	R1	R1E	RHS	R1S	R3S	R2	R3	
Limited	R	R	R	R	R	R	R	§ 4.10.090, Note 4
Expanded	U	U	U	A	A	U	A	§ 4.10.090
Domestic Animals								
Dogs & Cats	R	R	R	R	R	R	R	Note 5
Small Animals	R	R	R	R	R	R	R	Note 6
Horses	R	R	R	R	-	-	-	Note 7
Emergency Shelters								
Small-Scale	-	-	-	-	-	-	R	§ 4.10.115
Large-Scale	-	-	-	-	-	-	U	§ 4.10.115
Home Occupations								
General	R	R	R	R	R	R	R	§ 4.10.180
Expanded	S	S	S	S	S	S	S	§ 4.10.180, Note 8
Residential – Communal Institutional	U	U	U	-	-	U	U	
Rooming Houses, Fraternities, & Sororities	U	U	-	-	-	U	A	
Temporary Residence / Construction	R	R	R	R	R	R	R	§ 4.10.380

NOTES:

1. Single-family dwellings, including certain additions, and duplexes, may be subject to the building site approval provisions of Section C12-300 et seq. of the County Ordinance Code.
2. In R1S districts, ASA is required for new single-family residences on lots smaller than 10,890 square feet (0.25 acre). Two-family residences are not permitted on lots smaller than 10,890 square feet, and ASA is required for new two-family residences on lots smaller than 21,780 square feet (0.50 acre). ASA is not required for additions or remodels of existing dwellings.
3. In R3S districts, accessory structures not meeting the criteria of § 4.20.020 may be allowed subject to ASA.
4. Facilities qualifying as “Large-Family Day-Care Homes,” serving between 7 and 14 children, are subject to an administrative permit, per the provisions of Division B24 of the County Ordinance Code.

5. Not to exceed two (2) dogs and five (5) cats over four months of age on parcels less than five acres, or three (3) dogs and five (5) cats over four months of age on parcels five acres or more, unless the required permit is secured pursuant to Division B31 of the County Ordinance Code.
6. Small Animals – Limited. Not to exceed a total of twelve (12) of any of the following small animals: rabbits, guinea pigs, chicken and fowl, and similar species as approved by the Zoning Administrator. Roosters, peafowl, guinea fowl, geese or quacking ducks are not allowed.
7. Horses. Minimum lot size for the keeping of horses in urban residential districts is one-half acre. Not to exceed two horses per acre.
8. Expanded home occupations are permitted on lots of one acre or larger. See § 4.10.180 for other criteria.
9. Owner-occupancy of one unit is required in any single-family residence that contains a junior accessory dwelling unit. The owner may reside in either the single-family residence or the junior accessory dwelling unit. Owner-occupancy shall not be required if the owner is a governmental agency, land trust, or housing organization.

Table 2.30-2

**NON-RESIDENTIAL USE CLASSIFICATIONS
IN URBAN RESIDENTIAL BASE DISTRICTS**

- R** Permitted by Right
- C** Planning Clearance
- S** Special Permit (Ch 5.60)
- A** ASA (Ch 5.40)
- U** Use Permit/ ASA (Ch 5.65, 5.40)
- Not Permitted

USE CLASSIFICATIONS	ZONING							Supplemental Regulations
	R1	R1E	RHS	R1S	R3S	R2	R3	
Agriculture								
General	-	-	R	-	-	-	-	Note 1
Livestock	-	-	R	-	-	-	-	Note 1
Urban	R	R	R	R	R	R	R	§ 4.10.025
Antennas – Commercial								
Minor	A	A	A	A	A	A	A	
Major	U	U	U	A	A	U	U	
Churches (See “Religious Institutions”)								
Community Care								
Limited	R	R	R	R	R	R	R	§ 4.10.090, Note 3
Expanded	U	U	U	A	A	U	A	§ 4.10.090
Emergency Shelters								
Small-Scale	-	-	-	-	-	-	R	§ 4.10.115
Large-Scale	-	-	-	-	-	-	U	§ 4.10.115
Golf Courses & Country Clubs	U	U	-	-	-	-	-	

Table 2.30-2

**NON-RESIDENTIAL USE CLASSIFICATIONS
IN URBAN RESIDENTIAL BASE DISTRICTS**

R Permitted by Right
C Planning Clearance
S Special Permit (Ch 5.60)
A ASA (Ch 5.40)
U Use Permit/ ASA (Ch 5.65, 5.40)
- Not Permitted

USE CLASSIFICATIONS	ZONING							Supplemental Regulations
	R1	R1E	RHS	R1S	R3S	R2	R3	
Historic Structures – Use Conversion	-	-	A	-	-	-	-	§ 4.10.170
Hospitals & Clinics	U	U	U	A	A	U	U	
Museums	U	U	U	A	A	U	U	
Nonprofit Institutions	U	U	U	A	A	U	U	Note 6
Religious Institutions	U	U	U	A	A	U	U	Note 6
Retail Sales & Services – Local Serving	-	-	-	A	A	-	A	Notes 2, 7
Schools	U	U	U	A	A	U	U	
Swim & Tennis Clubs	U	U	U	A	A	U	U	
Utilities and Public Facilities								Note 4
Minor	A	A	A	A	A	A	A	
Major	U	U	U	A	A	U	U	
Wireless Telecommunication Facilities								Note 5
Collocation/Modification - Minor	R	R	R	R	R	R	R	§ 4.10.400
Collocation/Modification – Major	A	A	A	A	A	A	A	§ 4.10.400
New Facilities	A	A	A	A	A	A	A	§ 4.10.400

NOTES:

1. On lots 2.5 acres or larger in RHS districts, all agricultural uses permitted in HS districts as a matter of right (see Table 2.20-2) shall be allowed.
2. Commercial and service uses permitted in R1S, R3S and R3 districts shall be limited in scale and in their service market to primarily serve the residents of the subject residential development. For residential support uses in R1S and R3S districts applicable to Stanford University lands, a business plan is required demonstrating that a preponderance of customers will be Stanford residents or employees.
3. Facilities qualifying as “Large-Family Day-Care Homes,” serving between 7 and 14 children, are subject to an administrative permit, per the provisions of Division B24 of the County Ordinance Code.

4. Utility structures and facilities may be exempt from local zoning regulations if they are established by a government agency. There may also be federal or state laws that provide exemptions for certain types of utilities.
5. Wireless telecommunications facilities are exempt from the development standards listed in Table 2.30-3.
6. Established *Religious Institutions* and *Nonprofit Institutions* may include *Emergency Shelters: Small-Scale* as an ancillary use by right.
7. In R3 zoning districts, any use that involves the sale or onsite consumption of alcoholic beverages shall be subject to a use permit

SECTION 5. Section 2.40.020 of Chapter 2.40, Article 2 of Appendix I, Zoning, of the County of Santa Clara Ordinance Code, is amended as follows:

§ 2.40.020 Use Regulations

The following table, Table 2.40-1, specifies the allowable land uses for the commercial and industrial base districts, listed by use classification as defined in Chapter 2.10. The regulations for each district are established by letter designations as follows:

- “R” designates use classifications that are permitted by right. The term “by right” indicates no discretionary permit process by the Planning Office is required. Compliance with zoning standards will be confirmed during the building permit process, where applicable. See subsection 1.20.040(D) for applicability of other rules and processes.
- “C” designates use classifications that require an administrative planning clearance from the Planning Office. Planning clearances are for uses that require adherence to the Zoning Ordinance but for which no discretionary permit from the Planning Office is required.
- “S” designates use classifications permitted with a special permit, subject to the provisions of Chapter 5.60, Special Permit.
- “A” designates use classifications permitted with architecture and site approval, subject to the provisions of Chapter 5.40, Architecture and Site Approval.
- “U” designates use classifications permitted with a use permit, and architecture and site approval, subject to the provisions of Chapter 5.65, Use Permit, and Chapter 5.40, Architecture and Site Approval.
- “_” designates use classifications that are not allowed.

Supplemental regulations for the establishment and conduct of a use are referenced in the “Supplemental Regulations” column of the table. Use classifications not listed in the table are prohibited in the commercial and industrial base districts.

Table 2.40-1

**USES IN COMMERCIAL AND INDUSTRIAL
BASE DISTRICTS**

- R** Permitted by Right
- C** Planning Clearance
- S** Special Permit (Ch 5.60)
- A** ASA (Ch 5.40)
- U** Use Permit/ASA (Ch 5.65, 5.40)
- Not Permitted

USE CLASSIFICATIONS	ZONING					Supplemental Regulations
	CN	CG	OA	ML	MH	
Accessory Dwelling Units						
Standard ADUs	R	R	R	–	–	§ 4.10.015
Movable tiny homes	C	C	C	–	–	§ 4.10.015
Junior ADUs	R	R	R	–	–	§ 4.10.015, Note 11
Adult Uses	–	U	–	U	U	§ 4.10.020
Agriculture						
General	–	–	–	–	–	
Livestock	–	–	–	–	–	
Urban	R	R	R	R	R	§ 4.10.025
Antennas – Commercial						
Minor	A	A	A	A	A	
Major	U	U	U	U	U	
Auction Houses	–	–	–	A	A	
Automobile Sales & Services						
Limited Repair	–	U	–	A	A	Note 1 (CG)
General Repair	–	–	–	A	A	
Sales & Rentals	–	U	–	A	A	
Service Stations	U	U	–	A	A	
Storage	–	–	–	A	A	
Washing	U	U	–	A	A	
Banks	A	A	–	A	A	
Billboards	U	U	–	U	U	
Broadcasting	–	–	–	U	U	
Business Services	A	A	–	A	A	
Caretakers’ Residences	–	–	–	U	U	
Churches (See “Religious Institutions”)						
Clubs, Private & Nonprofit	U	U	–	U	U	
Colleges & Vocational Schools	–	U	–	U	U	

Table 2.40-1

**USES IN COMMERCIAL AND INDUSTRIAL
BASE DISTRICTS**

R Permitted by Right
C Planning Clearance
S Special Permit (Ch 5.60)
A ASA (Ch 5.40)
U Use Permit/ASA (Ch 5.65, 5.40)
- Not Permitted

USE CLASSIFICATIONS	ZONING					Supplemental Regulations
	CN	CG	OA	ML	MH	
Community Care						
Limited	R	R	R	R	R	§ 4.10.090, Note 2
Expanded	U	U	U	U	U	§ 4.10.090
Contractors' Facilities	-	-	-	A	A	
Emergency Shelters						
Small-Scale	R	R	R	R	R	§ 4.10.115
Large-Scale	U	U	U	U	U	§ 4.10.115
Food Preparation & Catering Services	A	A	-	A	A	
Funeral & Cremation Services	-	U	-	A	A	
Health & Fitness Clubs	-	A	-	A	A	
Hospitals & Clinics	U	U	U	U	U	
Hotels & Motels	U	U	-	-	-	
Kennels – Commercial	-	U	-	A	A	§ 4.10.200
Laboratories & Testing Services	-	-	A	A	A	
Laundries – Industrial	-	U	-	U	A	
Machinery & Equipment Services						
Limited	U	A	-	A	A	
General	-	-	-	A	A	
Maintenance & Repair Services	A	A	-	A	A	
Manufactured-Home Sales & Rentals	-	-	-	U	U	
Manufacturing						
Limited	-	-	-	A	A	
General	-	-	-	U	A	
Intensive	-	-	-	-	U	
Massage Establishments	A	A	A	-	-	Note 3
Museums	U	U	U	U	U	
Nonprofit Institutions	U	U	U	U	U	Note 9

Table 2.40-1

**USES IN COMMERCIAL AND INDUSTRIAL
BASE DISTRICTS**

- R** Permitted by Right
- C** Planning Clearance
- S** Special Permit (Ch 5.60)
- A** ASA (Ch 5.40)
- U** Use Permit/ASA (Ch 5.65, 5.40)
- Not Permitted

USE CLASSIFICATIONS	ZONING					Supplemental Regulations
	CN	CG	OA	ML	MH	
Nurseries						
Retail	A	A	–	A	A	
Wholesale	–	–	–	A	A	
Offices	A	A	A	A	A	
Parking Services & Facilities	–	A	–	A	A	
Personal Services	A	A	–	A	A	
Petroleum Products Distribution	–	–	–	U	U	
Recreation – Commercial	–	U	–	U	–	
Recycling						
Collection Facilities – Consumer Recycling	R	R	R	R	R	§ 4.10.285
Recycling/ Processing Facilities – Consumer Waste	–	–	–	–	U	
Concrete, Asphalt, & Soil Recycling	–	–	–	–	U	
Composting & Wood Recycling	–	–	–	–	U	
Hazardous Materials	–	–	–	–	U	
Religious Institutions	U	U	U	U	U	Note 9
Residences						
Single-Family	U	U	U	–	–	Note 5 (CN, CG) Note 6 (ML, MH)
Two-Family	U	U	U	–	–	Note 5 (CN, CG) Note 6 (ML, MH)
Multi-Family	U	U	U	–	–	Note 5 (CN, CG) Note 6 (ML, MH)
Residential Accessory Structures & Uses	R	R	R	R	R	§ 4.20.020
Restaurants & Bars						
Limited-Service Eating Places	A	A	–	A	A	
Full-Service Eating Places	U	U	–	U	U	
Drinking Places	U	U	–	U	U	

Table 2.40-1

**USES IN COMMERCIAL AND INDUSTRIAL
BASE DISTRICTS**

- R** Permitted by Right
- C** Planning Clearance
- S** Special Permit (Ch 5.60)
- A** ASA (Ch 5.40)
- U** Use Permit/ASA (Ch 5.65, 5.40)
- Not Permitted

USE CLASSIFICATIONS	ZONING					Supplemental Regulations
	CN	CG	OA	ML	MH	
Retail Sales & Services						
Local-Serving	A	A	–	–	–	Note 10
General	A	A	–	A	A	Note 10
Outdoor Sales & Storage	–	U	–	A	A	Note 10
Schools	U	U	U	U	U	
Studios, Arts & Crafts	A	A	–	A	A	
Taxidermy	–	–	–	A	A	
Theaters	–	U	–	U	–	
Truck & Railroad Terminals	–	–	–	A	A	
Truck Sales & Services						
Repair	–	–	–	A	A	
Sales	–	–	–	A	A	
Storage	–	–	–	A	A	
Utilities and Public Facilities						Note 7
Minor	A	A	A	A	A	
Major	U	U	U	U	U	
Warehousing & Storage						
Indoor	–	–	–	A	A	
Outdoor	–	–	–	A	A	
Wholesaling & Distribution	–	–	–	A	A	
Wireless Telecommunication Facilities						
Co-location	A	A	A	A	A	§ 4.10.400, Note 8
Minor	A	A	A	A	A	§ 4.10.400
Major	U	U	U	U	U	§ 4.10.400

NOTES:

1. In CG districts, limited auto rental establishments, including a business office and not more than 10 cars (stock) on site at any time, are not subject to a use permit, only ASA.

2. Facilities qualifying as “Large-Family Day-Care Homes,” serving between 7 and 14 children, are subject to an administrative permit, per the provisions of Division B24 of the County Ordinance Code.
3. Massage establishments shall comply with the provisions of Division B22 of the County Ordinance Code.
4. [Reserved]
5. Commercial/ residential mixed uses are permitted in CN and CG districts subject to use permit and ASA.
6. Expansion or replacement of legal-nonconforming residence in ML and MH districts subject to use permit, per § 4.50.060.
7. Utility structures and facilities may be exempt from local zoning regulations if they are established by a government agency. There may also be federal or state laws that provide exemptions for certain types of utilities.
8. Co-location of wireless telecommunication facilities may be eligible for an ASA administrative review and approval (§ 5.40.050), where consistent with the provisions of this ordinance. Where the proposed co-location meets the criteria in Government Code § 65850.6(b) relating to previously approved facilities permitted by a means of a discretionary permit issued on or after January 1, 2007, and either a negative declaration, mitigated negative declaration, or environmental impact report was prepared and adopted, the co-location shall be reviewed for consistency with the approved plans, mitigation requirements, and conditions imposed on the existing facility, and if found consistent, will be subject only to a building permit or other applicable permits required by Title C of the County Ordinance Code.
9. Established *Religious Institutions* and *Nonprofit Institutions* may include *Emergency Shelters: Small-Scale* as an ancillary use by right.
10. Any use that involves the sale or onsite consumption of alcoholic beverages shall be subject to a use permit.
11. Owner-occupancy of one unit is required in any single-family residence that contains a junior accessory dwelling unit. The owner may reside in either the single-family residence or the junior accessory dwelling unit. Owner-occupancy shall not be required if the owner is a governmental agency, land trust, or housing organization.

SECTION 6. Section 2.50.020 of Chapter 2.50, Article 2 of Appendix I, Zoning, of the County of Santa Clara Ordinance Code, is amended as follows:

§ 2.50.020 Use Regulations

The following table, Table 2.50-1, specifies the allowable land uses for the special purpose base districts, listed by use classification as defined in Chapter 2.10. The regulations for each district are established by letter designations as follows:

- “R” designates use classifications that are permitted by right. The term “by right” indicates no discretionary permit process by the Planning Office is required. Compliance with zoning standards will be confirmed during the building permit process, where applicable. See subsection 1.20.040(D) for applicability of other rules and processes.
- “C” designates use classifications that require an administrative planning clearance from the Planning Office. Planning clearances are for uses that require adherence to the Zoning Ordinance but for which no discretionary permit from the Planning Office is required.

- “S” designates use classifications permitted with a special permit, subject to the provisions of Chapter 5.60, Special Permit.
- “A” designates use classifications permitted with architecture and site approval, subject to the provisions of Chapter 5.40, Architecture and Site Approval.
- “U” designates use classifications permitted with a use permit, and architecture and site approval, subject to the provisions of Chapter 5.65, Use Permit, and Chapter 5.40, Architecture and Site Approval.
- “–” designates use classifications that are not allowed.

Supplemental regulations for the establishment and conduct of a use are referenced in the “Supplemental Regulations” column of the table. Use classifications not listed in the table are prohibited in the special purpose base districts.

Table 2.50-1

USES IN SPECIAL PURPOSE BASE DISTRICTS

- R** Permitted by Right
- C** Planning Clearance
- S** Special Permit (Ch 5.60)
- A** ASA (Ch 5.40)
- U** Use Permit/ ASA (Ch 5.65, 5.40)
- Not Permitted

USE CLASSIFICATIONS	ZONING				Supplemental Regulations
	A1	RS	OS/F	SCA	
Accessory Dwelling Units					
Standard ADUs	R	R			§ 4.10.015
Movable tiny homes	C	C			§ 4.10.015
Junior ADUs	R	R			§ 4.10.015, Note 19
Adult Uses	U	–	–	–	§ 4.10.020
Agriculture	R	R	R	R	Note 1 (OS/F and SCA)
Agricultural Accessory Structures & Uses	R	R	A	–	§ 4.20.020, Note 2 (OS/F)
Agricultural Employee Housing					
Short Term	S	–	–	–	§ 4.10.040, Note 16
Long Term	U	–	–	–	§ 4.10.040, Note 16

Table 2.50-1
USES IN SPECIAL PURPOSE BASE DISTRICTS

R Permitted by Right
C Planning Clearance
S Special Permit (Ch 5.60)
A ASA (Ch 5.40)
U Use Permit/ ASA (Ch 5.65, 5.40)
- Not Permitted

USE CLASSIFICATIONS	ZONING				Supplemental Regulations
	A1	RS	OS/F	SCA	
Agricultural Equipment Sales & Services	U	-	-	-	
Agricultural Processing					
Small Scale	R	-	A	-	§ 4.10.030; Notes 2, 3 (OS/F)
Medium Scale	A	-	-	-	§ 4.10.030
Large Scale	U	-	-	-	§ 4.10.030
Agricultural Research	A	-		A	
Agricultural Sales					
Limited	R	R	A	-	§ 4.40.110 (Signs), Notes 2, 3 (OS/F)
Farmers' Markets	U	U	-	-	
Agriculturally Related Entertainment & Commercial Uses	U	U	-	-	§ 4.10.050
Antennas – Commercial					
Minor	A	A	A	-	
Major	U	U	A	-	
Auction Houses	U	-	-	-	
Automotive Sales & Services					
Limited Repair	U	-	-	-	
General Repair	U	-	-	-	
Sales & Rentals	U	-	-	-	
Service Stations	U	U	-	-	
Storage	U	-	-	-	
Washing	U	-	-	-	
Banks	U	-	-	-	
Bed & Breakfast Inns	U	U	-	-	§ 4.10.060
Billboards	U	-	-	-	
Broadcasting	U	-	-	-	

Table 2.50-1
USES IN SPECIAL PURPOSE BASE DISTRICTS

R Permitted by Right
C Planning Clearance
S Special Permit (Ch 5.60)
A ASA (Ch 5.40)
U Use Permit/ ASA (Ch 5.65, 5.40)
- Not Permitted

USE CLASSIFICATIONS	ZONING				Supplemental Regulations
	A1	RS	OS/F	SCA	
Business Services	U	-	-	-	
Butcheries	U	-	-	-	
Camps & Retreats	-	-	-	-	
Caretaker’s Residences	U	-	A	-	Note 4 (OS/F)
Cemeteries	U	-	-	-	
Churches (See “Religious Institutions”)					
Clubs – Private & Nonprofit	U	-	-	-	
Colleges & Vocational Schools	U	-	-	-	
Community Care					
Limited	R	R	-	-	§ 4.10.090, Note 5
Expanded	U	U	-	-	§ 4.10.090
Contractors’ Facilities	U	-	-	-	
Dairies	U	-	-	-	
Domestic Animals	R	R	-	-	
Emergency Shelters					
Small-Scale	R	R	-	-	§ 4.10.115
Large-Scale	U	-	-	-	§ 4.10.115
Feed Lots	U	-	-	-	
Field Research	R	R	R	R	Note 2 (OS/F & SCA)
Food Preparation & Catering Services	U	-	-	-	
Funeral & Cremation Services	U	-	-	-	
Golf Courses & Country Clubs	U	-	-	-	§ 4.10.140(B)
Golf Driving Ranges	U	-	-	-	§ 4.10.150(B)
Health & Fitness Clubs	U	-	-	-	
Helipads	U	-	-	-	§ 4.10.160
Historic Structure – Use Conversion	A	A	-	-	§ 4.10.170

Table 2.50-1
USES IN SPECIAL PURPOSE BASE DISTRICTS

R Permitted by Right
C Planning Clearance
S Special Permit (Ch 5.60)
A ASA (Ch 5.40)
U Use Permit/ ASA (Ch 5.65, 5.40)
- Not Permitted

USE CLASSIFICATIONS	ZONING				Supplemental Regulations
	A1	RS	OS/F	SCA	
Home Occupations					
General	R	R	-	-	§ 4.10.180
Expanded	S	S	-	-	§ 4.10.180
Hospitals & Clinics	U	-	-	-	
Hotels & Motels	U	U	-	-	
Kennels	U	-	-	-	§ 4.10.200
Laboratories & Testing Services	U	-	-	-	
Laundries – Commercial	U	-	-	-	
Livestock Auction Yards	U	-	-	-	§ 4.10.210
Machinery & Equipment Services					
Limited	U	-	-	-	
General	U	-	-	-	
Maintenance & Repair Services	U	-	-	-	
Manufactured-Home Sales & Rentals	U	-	-	-	
Manufacturing					
Limited	U	-	-	-	
General	U	-	-	-	
Intensive	U	-	-	-	
Massage Establishments	U	-	-	-	Note 8
Museums	U	-	-	-	
Mushroom Farms	U	-	-	-	§ 4.10.220
Nonprofit Institutions	U	-	-	-	Notes 18
Nurseries					
Retail	U	-	-	-	
Wholesale	U	-	-	-	
Offices	U	-	-	-	
Oil and Gas Extraction	U	-	-	-	
Parking Services & Facilities	U	-	-	-	

Table 2.50-1
USES IN SPECIAL PURPOSE BASE DISTRICTS

R Permitted by Right
C Planning Clearance
S Special Permit (Ch 5.60)
A ASA (Ch 5.40)
U Use Permit/ ASA (Ch 5.65, 5.40)
- Not Permitted

USE CLASSIFICATIONS	ZONING				Supplemental Regulations
	A1	RS	OS/F	SCA	
Personal Services	U	-	-	-	
Petroleum Products Distribution	U	-	-	-	
Poultry & Egg Farms	U	-	-	-	§ 4.10.240
Radio-Controlled Model Aircraft Facilities	U	-	-	-	§ 4.10.250
Reception Facilities	U	-	-	-	§ 4.10.260
Recreation – Commercial	U	-	-	-	
Recreational Playgrounds & Sports Fields	U	-	-	-	
Recreational Vehicle Parks	U	U	-	-	§ 4.10.280
Recycling Facilities					
Collection Facilities – Consumer Recycling	R	-	-	-	§ 4.10.285
Recycling/ Processing Facilities – Consumer Waste	U	-	-	-	
Concrete, Asphalt, & Soil Recycling	U	-	-	-	
Composting & Wood Recycling	U	-	A		Notes 2, 9 (OS/F), 19
Hazardous Materials	U	-	-	-	
Religious Institutions	U	-	-	-	Notes 18
Residential					
Single-Family	R	U	-	-	Note 10
Two-Family	U	-	-	-	
Multi-Family	U	-	-	-	
Residential Accessory Structures & Uses	R	R	-	-	§ 4.20.020
Residential – Communal Institutional	U	-	-	-	
Restaurants and Bars					
Limited-Service Eating Places	U	U	-	-	
Full-Service Eating Places	U	U	-	-	
Drinking Places	U	U	-	-	

Table 2.50-1
USES IN SPECIAL PURPOSE BASE DISTRICTS

R Permitted by Right
C Planning Clearance
S Special Permit (Ch 5.60)
A ASA (Ch 5.40)
U Use Permit/ ASA (Ch 5.65, 5.40)
- Not Permitted

USE CLASSIFICATIONS	ZONING				Supplemental Regulations
	A1	RS	OS/F	SCA	
Retail Sales & Services					
General	U	U	-	-	Note 6 (RS)
Outdoor Sales & Storage	U	-	-	-	
Rodeos & Equestrian Events	U	-	-	-	
Rooming Houses, Fraternities, & Sororities	U	-	-	-	
Schools	U	-	-	-	
Solar Energy Conversion Systems – Commercial					
Minor	A	-	-	-	§ 4.10.345
Major	U	-	-	-	§ 4.10.345
Sport Shooting	U	-	-	-	§ 4.10.350
Stables – Commercial	U	-	-	-	§ 4.10.360
Stanford – Specialized Facilities and Installations	-	-	A	-	Note 11 (OS/F)
Studios – Arts & Crafts	U	-	-	-	
Surface Mining	U	-	-	-	§ 4.10.370
Swim & Tennis Clubs	U	-	-	-	
Taxidermy	U	-	-	-	
Temporary Residences / Construction	R	R	-	-	§ 4.10.380
Theaters	U	-	-	-	
Timber Harvest Operations – Commercial	U	-	-	-	
Truck & Railroad Terminals	U	-	-	-	
Truck Sales & Services					
Repair	U	-	-	-	
Sales	U	-	-	-	
Storage	U	-	-	-	

Table 2.50-1
USES IN SPECIAL PURPOSE BASE DISTRICTS

R Permitted by Right
C Planning Clearance
S Special Permit (Ch 5.60)
A ASA (Ch 5.40)
U Use Permit/ ASA (Ch 5.65, 5.40)
- Not Permitted

USE CLASSIFICATIONS	ZONING				Supplemental Regulations
	A1	RS	OS/F	SCA	
Underground Mining	U	-	-	-	
Utilities and Public Facilities					Note 14
Minor	A	A	A	A	Notes 12, 13 (OS/F & SCA)
Major	U	U	A	A	Notes 12, 13 (OS/F & SCA)
Veterinary Clinics & Hospitals	U	-	-	-	
Warehousing & Storage					
Indoor	U	-	-	-	
Outdoor	U	-	-	-	
Well-Drilling Operations	U	-	-	-	
Wholesaling & Distribution	U	-	-	-	
Wind Energy Conversion Systems – Commercial	U	U	-	-	§ 4.10.390
Wineries					
Small-Scale	R	R	-	-	§ 4.10.395, § 4.40.110 (Signs)
Medium-Scale	S	S	-	-	§ 4.10.395, § 4.40.110
Large-Scale	U	U	-	-	§ 4.10.395, § 4.40.110
Wireless Telecommunication Facilities					
Co-location	A	A	A	-	§ 4.10.400, Note 15
Minor	A	A	A	-	§ 4.10.400
Major	U	U	A	-	§ 4.10.400

NOTES:

1. Within the OS/F district, tree farm operations that grow trees in containers or in the ground are consistent with the “Agriculture” use classification. Within the SCA district, agricultural uses shall be limited to non-riparian areas and areas outside of conservation easements and California tiger salamander (CTS) reserve areas managed pursuant to the Stanford Habitat Conservation Plan (HCP), except for grazing for vegetation management as specifically provided in the Stanford HCP. Within the riparian areas and conservation easement/CTS reserve areas of the SCA district, use of pesticides and herbicides shall be

prohibited; however, this does not prohibit weed abatement activities, non-native wildlife or plant abatement activities (including the use of pesticides, biocides, and herbicides or other agricultural chemicals) conducted in accordance with the Stanford HCP or Stanford Special Conservation Areas Plan (SCAP).

2. Within the OS/F district, structures ancillary to any allowed use or activity are permitted subject to the requirements of ASA (Chapter 5.40 and subsection 2.50.040(B)). Within the SCA district, no new permanent development in the form of buildings or structures is allowed, except for the construction, modification, and maintenance of improvements to support conservation efforts; structures or improvements that are necessary for safety reasons; small markers or other identifiers indicating the presence of sensitive resources (such as Native American remains); new signs, bridges, utilities, erosion control improvements; and fences; provided that they are constructed in accordance with the terms of the Stanford HCP and SCAP. This provision shall not prohibit maintenance of existing structures or improvements or prohibit the replacement of structures or improvement with new structures or improvements that serve the same purpose as the existing structures or improvements, provided any new or modified structures or improvements located within the HCP conservation easement/CTS reserve areas are approximately the same size as the existing structures or improvements.
3. Within the OS/F district, agricultural processing is limited to low intensity processing and agricultural sales activities that would not significantly impact local transportation patterns. For example, activities such as packaging products for off-site shipping and allowing limited on-site purchase of agricultural commodities are consistent with allowable uses for this district. Activities such as a canning operation, or establishing a commercial outlet for sale of multiple agricultural commodities, would exceed the intensity allowed in this district. Prior to establishment of any use or activity, the Planning Office must determine that such use or activity is of low intensity and consistent with the General Use Permit requirements for the OS/F district.
4. Within the OS/F district, caretaker's residences, as defined in § 2.10.030, are allowed as follows: A cumulative total of five caretaker's residences is allowed to the extent they are consistent with all provisions of the Stanford General Use Permit and the zoning ordinance. This cumulative total includes all legal existing residential structures within the OS/F district, including any that may be legal nonconforming uses. Any existing legal nonconforming caretaker's residences that existed on December 12, 2000 and have not been subsequently abandoned may continue to be utilized as caretaker residences. Stanford University bears the burden of establishing that any existing structure and use is legal or legal nonconforming. Consistent with all other provisions of the zoning ordinance, any legal structure that has been converted to a caretaker's residence may be relocated, replaced, or modified, so long as there is no cumulative increase in the overall square footage of all residential structures. Caretaker's residences are subject to ASA (Chapter 5.40 and subsection 2.50.040 (B)). Cumulative building area (square footage and building footprint) for the five caretaker's residences shall not exceed the total square footage of documented building area for all legal or legal nonconforming residential structures that existed in the OS/F district on December 12, 2000.
5. Facilities qualifying as "Large-Family Day-Care Homes," serving between 7 and 14 children, are subject to an administrative permit, per the provisions of Division B24 of the County Ordinance Code.
6. In Roadside Services (RS) districts, general retail sales uses must be limited in scale and ancillary to a permitted use that is primarily oriented toward serving the needs of the motoring public, consistent with the general plan.
7. The existing Stanford University Golf Course may be modified or reconfigured within its boundaries as they existed on December 12, 2000, but the Golf Course footprint may not be expanded. Modification or replacement of the golf course clubhouse or ancillary support facilities is permitted if consistent with all applicable provisions of the Community Plan, General Use Permit, and the zoning ordinance.
8. Massage establishments shall comply with the provisions of Division B22 of the County Ordinance Code.
9. Within the OS/F district, composting facilities are limited to those servicing Stanford University purposes, and no other communities, jurisdictions or uses (e.g., Stanford Shopping Center).

10. Single-family dwellings, including certain additions, may be subject to the building site approval provisions of Division C12-300-399 of the County Ordinance Code. In Roadside Services districts, single-family residential use is permitted only if incidental to and necessary to support a permitted non-residential use, as defined by the land use approval and conditions of that primary non-residential use.
11. Within the OS/F district, Stanford specialized facilities and installations are limited to those structures or facilities that require a remote setting, including but not limited to facilities for astronomical or atmospheric research. Only those structures or facilities that require isolation from sources of interference (such as noise, vibration, electromagnetic fields, or similar impediments) are allowed.
12. Within the OS/F and the SCA districts, existing utilities may be replaced if there is no increase in size or scale of aboveground structures. Above-ground disturbance resulting from the maintenance or replacement of such structures shall be restored to pre-disturbance condition. Within the SCA district, existing utilities may be replaced with utilities that serve the same purpose as the existing structures or improvements (provided the new or modified structures or improvements located within the HCP conservation easement/ CTS reserve areas are approximately the same size as the existing structures or improvements) and utilities are constructed in accordance with the terms of the Stanford HCP or SCAP.
13. Within the OS/F and the SCA districts, new utilities may be constructed that serve either Stanford or other lands if such facilities reasonably minimize degradation to the natural environment and maintain the predominantly natural appearance and habitat values of the setting. In addition, within the SCA district, new utilities may be constructed consistent with the purposes of the SCA district, provided they are in accordance with the terms of the Stanford HCP where covered by the Stanford HCP.
14. Utility structures and facilities may be exempt from local zoning regulations if they are established by a government agency. There may also be federal or state laws that provide exemptions for certain types of utilities.
15. Co-location of wireless telecommunication facilities may be eligible for an ASA administrative review and approval (§ 5.40.050), where consistent with the provisions of this ordinance. Where the proposed co-location meets the criteria in Government Code § 65850.6(b) relating to previously approved facilities permitted by a means of a discretionary permit issued on or after January 1, 2007, and either a negative declaration, mitigated negative declaration, or environmental impact report was prepared and adopted, the co-location shall be reviewed for consistency with the approved plans, mitigation requirements, and conditions imposed on the existing facility, and if found consistent, will be subject only to a building permit or other applicable permits required by Title C of the County Ordinance Code.
16. Agricultural employee housing units may, on a limited basis, be used to accommodate overnight tourist stays. See subsection 4.10.395(C)(2) for criteria and permitting requirements.
17. Bed and breakfast inns ancillary to on-site wineries, agricultural sales operations or other agriculturally related uses shall be subject to a special permit, in lieu of a use permit, provided they are situated within the primary residence on the property.
18. Established *Religious Institutions* and *Nonprofit Institutions* may include *Emergency Shelters: Small-Scale* as an ancillary use by right.
19. Owner-occupancy of one unit is required in any single-family residence that contains a junior accessory dwelling unit. The owner may reside in either the single-family residence or the junior accessory dwelling unit. Owner-occupancy shall not be required if the owner is a governmental agency, land trust, or housing organization.

SECTION 7. Section 3.40.030 of Chapter 3.40, Article 3 of Appendix I, Zoning, of the County of Santa Clara Ordinance Code, is amended as follows:

§ 3.40.030 -n₁ District (Los Altos)

To minimize the differences between the development standards of the County and those of the adjoining City of Los Altos, and to encourage residential development that better complements the character of existing development, the following regulations shall apply to residential development in zoning districts that contain the -n₁ designator.

A. Floor Area.

1. Except where the provisions of subsection C below are applicable, the following floor area limitations shall apply.
 - a. Lots of 10,000 square feet (net) or less: a floor area ratio not to exceed 0.35; and
 - b. Lots larger than 10,000 square feet (net): 3,500 square feet of floor area, plus one additional square foot of floor area per 10 square feet of lot area over 10,000 square feet, to a maximum total floor area of 5,700 square feet.
2. For the purposes of this section, floor area shall include:
 - a. The gross floor area (defined in Section 1.30.030) of dwellings;
 - b. A cumulative total of 800 square feet for all accessory dwelling units on a lot shall not count toward floor area.
 - c. Any exposed portions of basements where finish floor level immediately above is more than four (4) feet above grade (see Fig. 3.40-1). Window wells, as defined and required for egress by the California Building Code (CBC) or California Residential Code (CRC), shall be limited to 10% above the minimum dimensions required by the CBC and CRC, and;
 - d. All accessory buildings on any lot where the cumulative area of accessory buildings exceeds 500 square feet.
3. Floor area calculations shall be noted on building permit site plans. These computations must be calculated, verified, signed and stamped by a registered civil engineer, a licensed land surveyor, or a licensed architect.

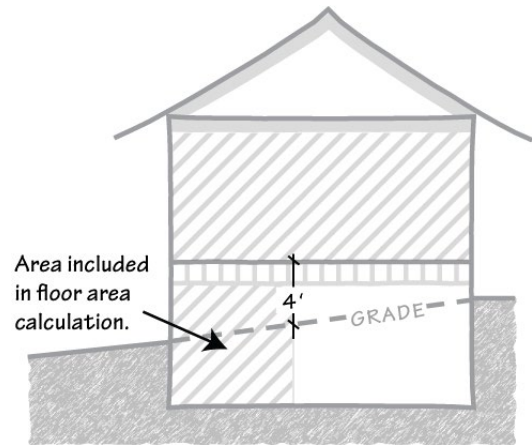

Fig. 3.40-1
Basement Floor Area

B. **Height of Dwellings.** The maximum height of dwellings shall be 27 feet.

C. **Special Development Standards for Underlying Lots.**

1. For the purposes of this subsection, “underlying lot” means any lot that meets all of the following criteria:
 - a. was contiguous to a lot under common ownership as of May 5, 1998;
 - b. was not separately developed and not approved as a single building site as of May 5, 1998; and
 - c. does not meet the minimum lot size of the applicable zoning district.

This definition shall also apply to lots resulting from the lot line adjustment of underlying lots, unless the resulting lot(s) meet(s) or exceed(s) the minimum size required by the zoning district. For the purposes of this provision, the term “lot line adjustment” includes adjustments that result in fewer lots than the original configuration.

2. Development of any individual underlying lot shall conform to the following special requirements:
 - a. Floor area ratio shall not exceed 0.25, except that any underlying lot larger than 16,660 square feet shall be subject to the standard floor area ratio formula of subsection A.1.b of this section.
 - b. Design review shall be required for any two-story house proposed. The review shall emphasize general neighborhood compatibility and impacts on adjacent properties.
 - c. Accessory buildings 500 square feet or smaller that would not be included in floor area calculations per subsection 3.40.030(A)(2)(c) shall only be excluded from floor area calculations if they are designed and used as garage or storage buildings exclusively. Such exempt buildings shall not contain integral heating, ventilation or air conditioning systems, and shall not include bathrooms.

SECTION 8. Section 3.40.040 of Chapter 3.40, Article 3 of Appendix I, Zoning, of the County of Santa Clara Ordinance Code, is amended as follows:

§ 3.40.040 -n₂ District (Burbank)

In recognition of the eclectic and historical character of housing within the central Burbank area, the following specific standards and requirements shall apply to all dwellings in zoning districts that contain the "-n₂" combining designation.

- A. **Front Yard Setbacks.** Front yard setbacks shall be 20 feet.
- B. **Floor Area Ratio.** Floor area ratio (FAR) shall not exceed 0.50. Floor area ratio calculations must be noted on building permit site plans. These computations must be verified, stamped and signed by either a licensed architect, registered civil engineer, or licensed land surveyor. A cumulative total of 800 square feet for all accessory dwelling units on a lot shall not count toward floor area.

SECTION 9. Section 3.50.090 of Chapter 3.50, Article 3 of Appendix I, Zoning, of the County of Santa Clara Ordinance Code, is amended as follows:

§ 3.50.090 -h₁ District (New Almaden)

- A. **Purpose.** The purpose of the “-h₁” combining district is to preserve the New Almaden National Historic Landmark District, one of 120 such places in California and only one of five in Santa Clara County recognized as being of such national historical significance. It was listed in the National Register of Historic Places in October 15, 1966, listing #66000236.

The boundaries of the “-h₁” historic preservation zoning district for New Almaden coincide with the boundaries of the National Historic Landmark District described by the National Register listing. The majority of the land area within the National Historic Landmark District is contained within the Almaden Quicksilver County Park, a regional park maintained by the Santa Clara County Parks and Recreation Department. Also included within this historic preservation zoning district are privately owned properties, the primary uses of which are residential.

For purposes of this ordinance, individually designated historic buildings and structures in the “-h₁” district are identified within either Priority List 1 or 2, including the Casa Grande (see subsection D, below). These structures and properties contribute significantly to the New Almaden National Historic Landmark District. All are located within what is defined within this ordinance as the Central Community Area (Sub-area A) along Almaden and Bertram Roads.

- B. **Use Regulations.** Uses within the “-h₁” district shall be limited to the following:
1. Uses permitted as a matter of right include:
 - a. Residence – Single-Family, including Residential Accessory Structures and Uses.
 - b. Agriculture, limited to uses permitted as a matter of right in the applicable base zoning district.
 - c. Community Care – Limited.
 - d. Home Occupations [Criteria/Findings, see § 4.10.180].

- e. Accessory dwelling units [Criteria/Findings, see § 4.10.015]
2. Uses permitted subject to the issuance of a special permit include:
 - a. Reserved.
 - b. Home Occupation – Expanded [Criteria/Findings, see § 4.10.180]
 - c. Residential Accessory Structures and Uses, with more than two internal plumbing fixtures, such as pool houses [Criteria/Findings, see § 4.20.020(I)]. This does not apply to accessory dwelling units.
 - d. Historic Structure – Use Conversion, as defined in Section 2.10.040, Non-Residential Use Classifications. Such uses may be established within any registered historic structure, provided that the approving authority makes all of the following findings:
 - i. the use is consistent with the intent of the “-h₁” zoning district.
 - ii. the use is consistent with the historical and architectural character of the community.
 - iii. the use conforms with the provisions of Section 4.10.170, Supplemental Use Regulations.
 - iv. the use conforms with any applicable supplemental use regulations of Chapter 4.10 concerning the particular use.
 3. Uses permitted subject to the issuance of architecture and site approval (ASA) include:
 - a. Utilities – Minor, as defined in Section 2.10.040.
 4. Uses permitted subject to the issuance of a use permit and architecture and site approval (ASA) include:
 - a. Nonprofit Institutions, such as community meeting facilities and other institutional uses serving the New Almaden community.
 - b. Utilities – Major, as defined in Section 2.10.040.

C. Special Development Standards:

1. **Front Setbacks for Almaden Road Priority List 1 Properties.** For individually designated historic structures along Almaden Road identified in Priority List 1, historic building placements relative to the road right-of-way shall be maintained. Front setback requirements for such properties along Almaden Road may be adjusted

without a variance if deemed by the zoning administrator to be in the interest of historic preservation and not in violation of the integrity of the zoning district.

2. **Minor adjustments to minimum yard and setback requirements.** Yard and setback requirements may be varied by the zoning administrator through the design review or ASA procedure if necessary, appropriate, and consistent with the intent of the historic zoning district. This provision is intended to allow for limited variation from standards without requiring a variance.
3. **Height.** Maximum building height shall be 35 feet, with no more than two (2) stories allowed. The provisions of subsection 4.20.020(E) shall apply to accessory buildings and structures.

D. **Designated Historic Structures of the New Almaden Historical Area.** As a National Historic Landmark District, the historic heritage and character of the early community of New Almaden are considered to be of great importance to the residents, the county, the state and the nation. To help preserve the historic character and value of New Almaden, the existing historic structures are prioritized in terms of their significance for preservation. [Note: The “1880 Map#” refers to the “1880 Mining Company Rental Map” on file with the County Planning Office, which depicts the locations of structures within the main community area existing at that time].

1. **Priority List No. 1.** The following properties are the designated as Priority List No. 1 historical structures:

Table 3.50-1

PRIORITY LIST 1

ADDRESS	APN	1880 MAP #	PLACENAME
21350 Almaden Rd.	583-18-044	None	Casa Grande
21472 Almaden Rd.	583-18-008	1	Head Mining Engineer’s House
21474 Almaden Rd.	583-18-007	2	Superintendent’s House
21490 Almaden Rd.	583-18-006	3	Engineer’s House
21498 Almaden Rd.	583-18-005	4	Robt. Scott’s House
21506 Almaden Rd.	583-18-004	5	Casa Nuestra
21512 Almaden Rd.	583-18-003	6	“La Mariposa”
21550 Almaden Rd.	583-17-038	11	“El Vespero”
21560 Almaden Rd.	583-17-037	12	Bulmore House
21570 Almaden Rd.	583-17-036	13	Carson-Perham Adobe
21590 Almaden Rd.	583-17-035	14	None

Table 3.50-1

PRIORITY LIST 1

ADDRESS	APN	1880 MAP #	PLACENAME
21600 Almaden Rd.	583-17-034	15	“La Casita de Adobe”
21620 Almaden Rd.	583-17-033	16	Doctor’s House
21661 Almaden Rd.	583-16-010	34	None
21671 Almaden Rd.	583-16-011	35	None
21684 Almaden Rd.	583-17-027	19	Employee’s Cottage
21692 Almaden Rd.	583-17-025	20	Employee’s Cottages
21700 Almaden Rd.	583-17-023	21	None
21744 Almaden Rd.	583-17-022	24-26	Toll Gate House
21733 Bertram Rd.	583-17-020	None	None
21747 Bertram Rd.	583-17-021	Hotel	“Hacienda Hotel” (La Foret Restaurant)

2. Preservation of Priority List No. 1 structures.

- a. Owners of the properties in Priority List No. 1 are especially encouraged to preserve and maintain these original structures of the Hacienda of New Almaden.
- b. The Casa Grande was the original residence of the mining company superintendent, and it has special historic and building significance. Therefore, it is required that any plans for interior or exterior remodeling, renovation and restoration be submitted to the County Historical Heritage Commission for review and recommendation.

3. Priority List No. 2. The following are the designated Priority List No. 2 historical structures:

Table 3.50-2

PRIORITY LIST 2

ADDRESS	APN	1880 MAP #	PLACENAME
21658 Almaden Rd.	583-17-030	23, (former site of 17	None. (House #23 was moved to the site and replaced House #17)

Table 3.50-2

PRIORITY LIST 2

ADDRESS	APN	1880 MAP #	PLACENAME
21790 Bertram Rd.	742-03-020	None	Helping Hand Hall, was “Dance Hall” before moved to present site
21800 Bertram Rd.	583-17-001	None	St. Anthony’s Church (built 1899)

4. **Preservation of Priority List No. 2 structures.** The structures in Priority List No. 2 are also important from a historical standpoint, even though they were moved from their original sites or were built at a later date, and they should be maintained in such a manner as to preserve their historical integrity and compatibility with Priority List No. 1 properties.

E. **Form, Materials, and Color Standards.** The following standards shall apply to all structures on properties on Priority Lists No. 1 and 2. Adherence is mandatory unless acceptable substitutes are approved as indicated in the provisions below.

For other properties not on either Priority List located within the “-h₁” district, these detailed standards are advisory. Certain features, materials, forms or approximations thereof may be required of a project by means of design review or ASA approval or conditions, as appropriate. Property owners are encouraged to incorporate these design features and materials standards into their construction plans as much as possible and appropriate to ensure the compatibility of new construction with the general historic character of the district. Substantial conformance with these standards is required for properties in the immediate vicinity of Priority List 1 and 2 properties, defined as the Central Community Area (“Sub-area A”), to ensure architectural compatibility with individually designated historic properties. (Refer to subsection F for further explanation of the Central Community Area).

1. **Exterior materials:**

- a. Board and batten.
- b. Ship lap.
- c. Wood siding (narrow “New England” style).
- d. Adobe sun-dried blocks, bituminous treated (the adobe may have a plaster coat).
- e. Reclaimed used red fired brick, or the early fire brick (Scottish).

2. **Roofing materials:** Wood shingles or shakes, fire retardant; constructed to comply with Uniform Building Code standards for Class “A” roofing for properties within

designated “Hazardous Fire Areas” as referenced in the County Fire Code, Division B7 of the County Ordinance Code.

3. **Exceptions to general exterior and roofing materials:** Other materials may be used provided they will closely resemble the materials specified above. Samples of the proposed substitute materials shall be submitted by the applicant to the County with the initial design review or other application for the project, to be examined for compliance and approval by the zoning administrator or other approval authority.
4. **Roof form:** Gable or sloping shed roof.
5. **Foundation:** New foundations may be of concrete construction providing one of the following is a part of the construction:
 - a. Added pigment in the concrete for resemblance to a soft red brick or earthen tan adobe.
 - b. A colored or painted plaster coating.
 - c. A board sheeting exterior veneer applied over the concrete.
6. **Garages:** Garages may be attached or detached and shall be constructed of materials listed and decorated as stated in these standards.
7. **Fencing:** New and replacement fencing shall be built of wood similar to the early wood fencing, or other historically compatible design and materials. Fences and hedges shall otherwise conform with provisions of Section 4.20.050.
8. **Painting and decorating:** New construction paint colors should be compatible with those that were used during the mid-to-late 1800s in this location. In general, color preferences from the time period were those from the natural color range, with emphasis on subdued, muted earth tones. Examples include, but are not limited to, grays, dark barn red, browns and tans.
9. **Window form:** Window forms were generally multi-light, such as 2 over 2, and they should be rectangular rather than round or arched.

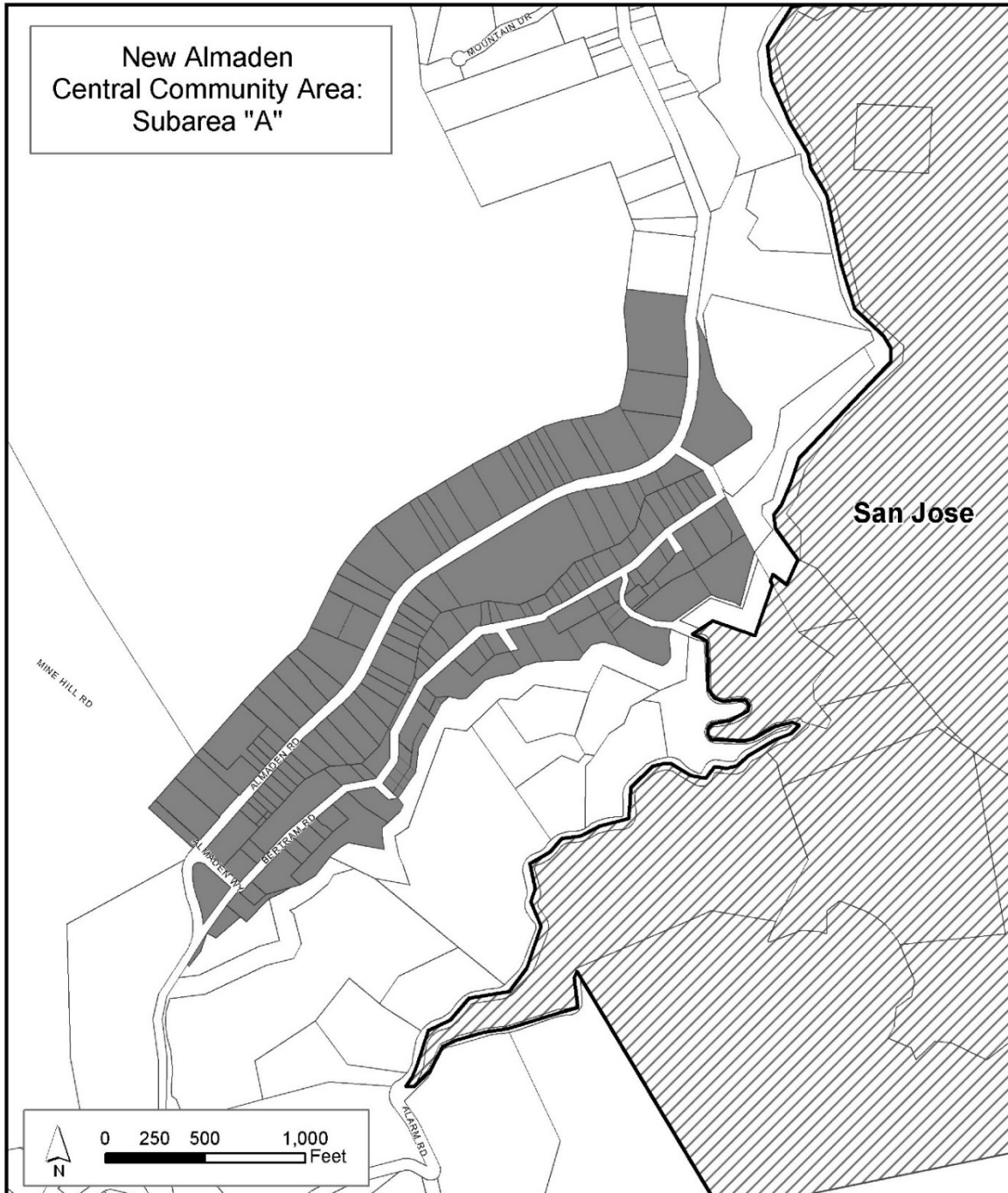

Fig. 3.50-1

F. General Requirements for Construction on Properties not on Priority Lists 1 or 2.

1. **Historic compatibility requirements in the Central Community Area (“Sub-area A”).** Within the designated central community area, delineated herein by the map entitled “New Almaden Historical Area—Sub-area A: Central Community Area,” new structures and modifications to existing structures on properties not within Priority List 1 or 2 shall be designed to ensure that their appearance is as compatible and complementary as possible with that of individually designated historic buildings and structures on Priority Lists 1 and 2.
2. **Historic compatibility requirements for all other properties.** Elsewhere within the “-h₁” district, outside the Central Community Area, new structures and modifications to existing structures should be designed for general compatibility with the historic character of the district. General adherence to the building form and material standards required for individually designated or registered historic structures is advised and encouraged, but complete conformance is not required. Comparable contemporary building forms and materials which generally approximate or resemble historic building form and materials are acceptable.
3. **Hillside development review in the New Almaden combining district.**
 - a. Hillside development within the “-h₁” historic zoning district— particularly proposed structures located on or near ridges or any hillside location of visual prominence—shall comply with the applicable provisions of the design review guidelines (or ASA guidelines) intended to ensure compatibility of development with the natural setting and to minimize visual impacts of development when viewed from the valley floor areas, scenic roads, and adjacent parklands.
 - b. Where necessary and appropriate, the zoning administrator is authorized to limit building height, size, massing, color, reflectivity, and location in order to minimize the potential obtrusiveness or incompatibility of a proposed structure with its surroundings.

G. Future Road and Street Development Policy.

1. Roadway development or improvements to existing roadways, including related infrastructure, should be consistent with the intent of this ordinance to preserve the historical character of the community, while also balancing the possible need for changes to ensure public health and safety. This policy particularly applies along the section of Almaden Road where it enters the “-h₁” district on the north (nearest San Jose) and extending to the south where it crosses Alamitos Creek.
2. For Almaden Road within the “-h₁” zoning district, it is recommended that the present road section should be adequately maintained, and any new road drainage

infrastructure should be designed and constructed to be compatible with the historic character of the district.

- H. **Sidewalks.** For new construction along the section of Almaden Road where there are existing sidewalks, sidewalks shall be of the same width and located similarly to the existing walk. New sidewalks shall be either red brick or concrete with red-brown pigment added to resemble the color of the native soil in the area. Existing red brick walks shall be left in place, maintained in good repair, and not paved over. Otherwise, provision of sidewalks shall not be required.
- I. **Road and Street Signing and Lighting.**
1. Street name signs and lettering should be rustic in nature. Materials may be either weathered wood or materials that simulate weathered wood in appearance. Sign lettering should be similar to the period and may be painted or routed in wood, provided that signage and lettering meet current standards for legibility and visibility at night. Two-way and four-way street name signs should be mounted on wood posts in a manner that is clearly visible and legible to motorists.
 2. Street lighting fixtures should be a traditional lantern type with standards that are of a dark brown, rust or black color.
- J. **Signs.** Signs shall be regulated in accordance with the provisions of Chapter 4.40 of this zoning ordinance.
- K. **Tree, Shrub, and Landscaping Conservation.**
1. The general conservation of existing trees and shrubs is strongly encouraged, subject to considerations of general public health and safety, particularly relating to fire safety and protection and to any tree or vegetation which poses a physical safety hazard.
 2. Trees and shrubs having a main trunk or stem measuring six (6) inches in diameter or greater (eighteen and eight tenths (18.8) inches in circumference), at a height of four and one-half (4.5) feet above ground, are protected trees, subject to the relevant provisions of the County's "Tree Preservation and Removal Ordinance," Division C16 of the County Ordinance Code. Except as otherwise provided in Division C16, Tree Preservation and Removal, an administrative permit or encroachment permit shall be required for the removal of any tree of such dimensions or greater within the "-h₁" New Almaden Historic Preservation zoning district.
 3. For development proposals subject to design review or other discretionary land use or development approval, the following provisions shall apply:

- a. Approval of a development application may be conditioned by the zoning administrator to retain the maximum number of trees and shrubs possible while still enabling the appropriate establishment of the allowed use and necessary site improvements.
- b. Special emphasis shall be given to preservation of mature native trees and shrubs and to those which provide mitigation for potential adverse visual impacts of development.
- c. Applications for design review or other discretionary land use approval on lots of one acre or less shall include plans showing all existing trees six (6) inches in diameter at a height of four and one-half (4.5) feet above ground, with a keyed listing of the species and diameter of such trees. Photographs of the trees and shrubs on the site shall be provided. For lots greater than one acre, plans shall indicate trees of these same dimensions and shrubs or hedges which are located in the proposed development area or which may be potentially affected by the development proposal, as well as any heritage trees located anywhere on the subject parcel.
- d. No healthy trees six (6) inches in diameter or greater measured four and one-half (4.5) feet above ground or significant hedges or shrubs shall be removed until after the effective date of a discretionary permit approval and then only as authorized by approved plans. All reasonable care shall be taken in grading, trenching, site preparation, and other construction operations to protect those trees, hedges, and shrubs required or identified to be retained.
- e. Trees and shrubs selected for new plantings and landscaping treatments should be native species typical of the hills and riparian areas specific to this district. Examples include the California sycamore, California oaks (primarily black oak, blue oak, coast live oak, and valley oak), California bay, and toyon. Non-native tree and shrub species, if used, should be typical of those used during the period of historical significance of the district. Some of the decorative species introduced during this period (1825 to 1875) include Moss roses and heritage variety roses, Italian cypress, lilacs and buddleia (shrubs and trees of the logania family commonly grown for their blossoms). All landscaping should blend with the general appearance of the riparian areas and surrounding hills as much as possible.

L. **Weed and Rubbish Abatement.** The County Fire Marshal classifies the New Almaden Historical Area as a high fire hazard zone. As a part of the “-h1” district standards, County Fire Code provisions concerning hazardous vegetation removal shall be complied with in all respects.

SECTION 10. Section 4.10.340 of Chapter 4.10, Article 4 of Appendix I, Zoning of the County of Santa Clara Ordinance Code, is repealed.

SECTION 11. Chapter 4.10, Article 4, of Appendix I, Zoning, of the County of Santa Clara Ordinance Code is amended to add Section 4.10.015 to read as follows:

§ 4.10.015 Accessory Dwelling Units

This section refers to uses classified as *Accessory Dwelling Units, which includes Standard ADUs, Movable Tiny Homes, and Junior ADUs*, as set forth in § 2.10.030. Such uses are subject to all of the following provisions:

- A. **Intent.** The intent of this section is to provide a valuable and relatively affordable form of housing for family members, the elderly, students, in-home health care providers, individuals with disabilities, and others, within existing neighborhoods and on existing legal lots. It is intended to regulate such housing units to ensure that they are relatively unobtrusive on the site, do not significantly impact adjacent properties, and do not diminish neighborhood character. This section and all other provisions of the zoning ordinance and Ordinance Code are intended to be consistent with, and shall be interpreted in a manner consistent with state law, including, but not limited to Government Code Sections 65852.2 and 65852.22, as those laws may be amended from time to time. If any provisions of the Zoning Ordinance or Ordinance Code are in conflict with state law, then those provisions shall be void and state law shall apply.
- B. **General Provisions.** All accessory dwelling units, including standard ADUs, Junior ADUs, and movable tiny homes, are required to comply with all of the following provisions. For the purposes of this section, one movable tiny home per lot is allowed in lieu of one standard ADU:
1. Only one accessory dwelling unit and one junior accessory dwelling unit are allowed per legal lot, with the exception of ADUs within existing multifamily dwelling units pursuant to subsections 4.10.015(C) and 4.10.015(D).
 2. Ministerial building permit applications to establish an accessory dwelling unit or junior accessory dwelling unit shall be reviewed by all applicable County departments and other public agencies for conformance with applicable standards and requirements and either approved or disapproved within 60 days after the County receives a complete application.
 3. No standard ADU or junior ADU may be sold separately from the primary residence or the real property upon which the primary residence is located. This provision does not apply to property built or developed by a qualified nonprofit corporation described in Government Code Section 65852.26.
 4. No building site approval pursuant to Ordinance Code Section C12-300 et seq. shall be required for accessory dwelling units. However, building site approval is required for the existing or proposed primary residence on the lot and shall be obtained before a building permit application for the accessory dwelling unit is submitted. Except where expressly exempt or otherwise provided in this Section 4.10.015, accessory

dwelling units are subject to all other applicable requirements of the Ordinance Code, including but not limited to requirements applicable to on-site wastewater treatment systems or sewer connections, water supply, setbacks, and height limitations.

5. Accessory dwelling units shall not be rented for terms shorter than 30-days.

C. **Attached Accessory Dwelling Units.** An attached accessory dwelling unit is a standard accessory dwelling unit that shares a roof, a foundation, and a common wall of at least eight (8) horizontal feet with the primary residence. It also includes a dwelling unit located entirely within the living area of the primary residence. Attached accessory dwelling units are subject to all of the following provisions:

1. Legally established primary residences that are 1,600 square feet or less, shall be allowed to have an attached ADU of no more than 800 square feet (Government Code section 65852.2(c)(2)(C)). Primary residences that are 1,601 – 2,400 square feet shall be allowed to have an attached ADU of no more than 50% of the legally established primary residence (Government Code section 65852.2(a)(1)(D)(iv)). Legally established primary residences exceeding 2,400 square feet shall be allowed to have an attached ADU of no more than 1,200 square feet (Government Code section 65852.2(c)).
2. Shall be setback at least four (4) feet from side and rear lot lines, and shall be subject to the same front yard setback as the primary residence, with the exception of conversions as stated in subsection 4.10.015(H).
3. Shall not exceed sixteen (16) feet in height if the dwelling unit does not comply with the setback limitations for a single-family residence, prescribed by the applicable zoning district.

If the accessory dwelling unit complies with the setback limitations for a single-family residence, the accessory dwelling unit shall be subject to the same height limitations as the single-family residence in the applicable zoning district, as measured from the lowest finished grade to the highest point of the structure.

4. Accessory dwelling units are allowed within the areas of a legally established multifamily dwelling structure that are not used as livable space, including but not limited to, storage rooms, boiler rooms, passageways, attics, basements, or garages, provided each accessory dwelling unit complies with state building standards for dwellings. At least one accessory dwelling unit may be attached within an existing multifamily dwelling structure. However, additional accessory dwelling units may not exceed twenty-five (25) percent of the existing legally established multifamily dwelling units. This provision shall only be applied once per property.

D. **Detached Accessory Dwelling Units.** A detached accessory dwelling unit is a structure that is separated from the primary residence by no less than six (6) horizontal feet. Detached accessory dwelling units are subject to all the following provisions:

1. Shall have a maximum floor area not exceeding 1,200 square feet.
2. Shall be setback at least four (4) feet from side and rear lot lines, and shall be subject to the same front yard setback as the primary residence, with the exception of conversions as stated in Section 4.10.015(H).
3. Shall not exceed sixteen (16) feet in height if the dwelling unit does not comply with the setback limitations for a single-family residence, as prescribed by the applicable zoning district.

If the accessory dwelling unit complies with the setback limitations for a single-family residence, the accessory dwelling unit shall be subject to the same height limitations as the single-family residence in the applicable zoning district, as measured from the lowest finished grade to the highest point of the structure.

Detached accessory dwelling units exceeding sixteen (16) feet in height shall incorporate a hip, gable, or other similar styled roof design.

4. An attached garage or carport of up to 400 square feet in floor area may be incorporated in the design of a detached accessory dwelling unit, provided the dwelling portion of the building does not exceed the applicable maximum floor area for the detached accessory dwelling unit (1,200 square feet).
5. Decks and porches, covered or uncovered, that are attached to a detached accessory dwelling unit are limited to a cumulative 400 square feet beyond the applicable maximum dwelling size (1,200 square feet). This limitation does not apply to any portion of an uncovered deck that is less than 30 inches above finished grade.
6. An attached junior accessory dwelling unit of up to an additional 500 square feet in floor area may be incorporated into a detached accessory dwelling unit. The cumulative square footage of both accessory dwelling units shall not exceed 1,700 square feet.
7. For properties with a multifamily dwelling, no more than two detached accessory dwelling units may be located on the same property.

E. **Movable Tiny Homes.** Movable tiny homes are subject to all of the following provisions:

1. Shall adhere to all setback, height, and floor area limitations pursuant to Section 4.10.015(D).
2. Shall be a self-contained unit that complies with all State of California requirements, is constructed in compliance with American National Standards Institute (ANSI) 119.5 standard as certified by an accredited qualified third-party inspector, and is licensed and registered with the California Department of Motor Vehicles.

3. Shall not move under its own power.
4. Shall be no larger than allowed by state law for movement on public highways.
5. Shall have at least 100 square feet of enclosed space.
6. Shall be directly connected to an approved water source, an onsite wastewater treatment system or sanitary sewer system, and electric utilities. Holding tanks that are incorporated into the original design of the structure shall not be used for the purposes of waste storage, and shall be directly connected to the approved onsite wastewater treatment system or sanitary sewer.
7. The undercarriage (wheels, axles, tongue and hitch) shall be hidden from view.
8. All wheels and leveling or support jacks shall sit on a surface acceptable to the County Building Official or designee.
9. Mechanical equipment shall be incorporated into the original design of the structure, and shall not be located on the roof or added on to the exterior of the unit.
10. Shall have the following design elements to maintain the character of the residential neighborhood:
 - a. Shall not include corrugated aluminum or fiberglass siding and shall not be a shipping container or cargo container.
 - b. Shall use cladding and trim materials on the exterior of movable tiny homes for residential appearance and to provide adequate thermal insulation and weather resistance. Materials may include, but are not limited to, single piece composite, vinyl siding, laminates, or interlocked sheathing.
 - c. Windows shall be at least double pane glass and labeled for building use, and shall include exterior trim.

F. **Junior Accessory Dwelling Units.** Junior accessory dwelling units are subject to all of the following provisions:

1. Shall be contained entirely within a single-family residence or a standard accessory dwelling unit.
2. When located within a single-family residence, the junior accessory dwelling unit shall adhere to all setback and height limitations pursuant to subsections 4.10.015(C)(2) and 4.10.015(C)(3).

When located within a standard accessory dwelling unit, the junior accessory dwelling unit shall adhere to all setback and height limitations pursuant to subsections 4.10.015(D)(2) and 4.10.015(D)(3).

3. Shall contain a full kitchen or an efficiency kitchen consisting of cooking facilities with appliances, food preparation counters, and storage cabinets that are of reasonable size.
4. Owner-occupancy of one unit is required in any single-family residence that contains a junior accessory dwelling unit. The owner may reside in either the single-family residence or the junior accessory dwelling unit. Owner-occupancy shall not be required if the owner is a governmental agency, land trust, or housing organization.
5. No parking space is required for a junior accessory dwelling unit. [See subsection 4.10.015(I)]

G. **Standard accessory dwelling units attached to accessory structures, excluding garage(s).** A standard accessory dwelling unit may be attached to an accessory structure provided that the habitable space of the standard accessory dwelling unit does not exceed a maximum size of 1,200 square feet. A standard accessory dwelling unit with a junior accessory dwelling unit that is attached to an accessory structure shall comply with subsection 4.10.015(D)(6).

1. The portion of the structure utilized as a dwelling unit shall comply with the height and setback regulations in subsection 4.10.015(D)(2).
2. There shall be no interior access connecting the dwelling unit portion of the structure to the non-dwelling portion of the structure. The common walls (including the floor and ceiling) between any dwelling unit portion and any non-dwelling portion shall comply with all fire separation requirements. Restrictions on heating, plumbing and/or electricity, the layout and partitioning of the non-habitable portion, and other design limitations may be imposed by the zoning administrator to ensure public health and safety.

H. **Conversions.** The following provisions apply to accessory dwelling units created by the conversion of an existing and legal detached accessory building constructed with a final inspection prior to January 1, 2017, or from existing floor area within a primary residence.

1. **Detached accessory building conversion.** A setback non-conforming detached garage or other accessory building, constructed with a final inspection prior to January 1, 2017, may be rebuilt or converted into an accessory dwelling unit and no additional setback shall be required. An expansion of no more than 150 square feet beyond the same physical dimension of a setback non-conforming accessory building shall be permitted, so long as the expansion does not result in a greater setback encroachment. All applicable building code and other Ordinance Code provisions shall apply.

2. **Within Existing Single Family Residence.** An accessory dwelling unit may be created within the existing space of a single family residence, including the conversion of an attached garage. The accessory dwelling unit shall have independent exterior access from the existing structure, and the side and rear setbacks shall be sufficient for fire safety. Floor area limitations for the accessory dwelling unit shall be as stated in subsections 4.10.015(C) and (F) for attached accessory dwelling units and junior accessory dwelling units, respectively.

A setback non-conforming single family residence may be expanded by up to 150 square feet to accommodate an accessory dwelling unit, so long as the expansion does not result in a greater setback encroachment.

I. Parking.

1. **Number of Spaces:** One (1) off-street parking space is required for a standard accessory dwelling unit. No parking space is required for a junior accessory dwelling unit. For applicable parking exemptions, see subsection 4.10.015(I)(3).
2. **Retention of Parking Spaces.** Where an existing garage or carport is converted to an accessory dwelling unit that previously provided the required covered off-street parking for the primary residence, a replacement parking space shall not be required.
3. **Special Parking Exemptions:** Notwithstanding any other law or local regulation, no additional parking requirements shall apply to an accessory dwelling unit that meets one of the following requirements:
 - a. Is within one-half mile of public transit service and a designated point of access, such as a bus stop, light rail station, or any similar facility.
 - b. Is within a –h, Historic Preservation Combining Zoning District.
 - c. Is part of the existing primary residence or an existing accessory structure.
 - d. On-street parking permits are required but are not offered to the occupant of the accessory dwelling unit.
 - e. There is a car share vehicle located within one-block of the accessory dwelling unit, which is further defined herein as a designated parking or pickup/delivery location or facility operated by a car share service.

The applicant shall be required to provide evidence to support any of the above exemptions.

J. Accessory Dwelling Units Subject to Other Discretionary Approvals.

Notwithstanding any other provision of this zoning ordinance, all new accessory dwelling units, including those attached to or included in an existing structure, that are

located in certain combining districts shall comply with the following standards in lieu of the requirements and review procedures normally required in those combining districts:

1. New accessory dwelling units located in a -d, -d1, -d2, or -sr combining district shall be permitted by right, subject to compliance with a light reflectivity value (LRV) requirement of 45 or less that shall apply to the façade and roof. No other requirements shall apply. For accessory dwelling units created by converting existing floor area within an existing dwelling, this provision shall not apply unless an addition to the building footprint is proposed.
2. New accessory dwelling units located in the -h1 combining district shall be permitted by right, subject to compliance with the standards of Section 4.10.015(H)(1), except for properties listed as Priority List 1 or 2 properties identified in Section 3.50.090, which shall be subject to the requirements in Section 3.50.090(D), which include design review and recommendation by the Historic Heritage Commission to ensure the integrity of the historic resource is preserved. For accessory dwelling units created by converting existing floor area within an existing dwelling, this provision shall not apply unless there are proposed changes to exterior of the building.
3. A cumulative total of 800 square feet for all accessory dwelling units on a lot in the -n1 or -n2 combining district shall not be included in floor area calculations, pursuant to Sections 3.40.030 and 3.40.040.

SECTION 12. Section 4.20.090 of Chapter 4.20, Article 4 of Appendix I, Zoning, of the County of Santa Clara Ordinance Code, is amended as follows:

§ 4.20.090 Recreational and Similar Vehicles

A. **Storage of Recreational Vehicles.** The following provisions apply to recreational vehicles (RVs) and similar vehicles parked or stored on residential lots, and shall apply in all zoning districts. They do not apply to approved commercial or industrial RV storage uses, RV parks, temporary dwellings provided under subsection 4.20.090(B) Section 4.10.380, or movable tiny homes as defined in Section 1.30.030 that have been permitted by the County.

1. No RV, camper, trailer, boat or similar vehicle may be parked or stored within a front or side yard for a period of more than 72 hours within any one (1) calendar month; however, this provision shall not preclude such RV storage on portions of a front or side yard that are at least 75 feet from the front property line.
2. An RV, camper, trailer, boat or similar vehicle may be stored within a rear yard. On a corner lot abutting a key lot, such vehicles must additionally be set back from the side right-of-way a distance equal to the front yard setback of the adjacent key lot.

3. Any RV, camper, trailer, boat or similar vehicle stored on a lot must be registered to a resident of that lot.
4. No RV may be used for dwelling purposes while being parked or stored on the premises. Utility connections are not allowed except when necessary for limited maintenance activity.
5. Storage of RVs, campers, trailers, boats or similar vehicles in a manner inconsistent with the limitations of this section shall not be allowed, regardless of when such storage may have been established. This provision shall supersede any contrary provision of Chapter 4.50: Nonconforming Uses and Structures.

B. Use as Emergency Housing Following Casualty. A mobile home or recreational vehicle, including travel trailer, may be temporarily occupied on property where a fire, earthquake or other casualty has rendered the primary residence non-habitable. All of the following requirements shall apply:

1. The temporary dwelling must be removed from the premises within 90 days after the date of occupancy of the repaired or replacement dwelling, or two years following the date the casualty occurred, whichever occurs first.
2. Temporary mobile homes or travel trailers must be connected to a sanitary sewer or septic system approved by the Department of Environmental Health for the temporary occupancy use.

SECTION 13. Section 4.20.110 of Chapter 4.20, Article 4 of Appendix I, Zoning, of the County of Santa Clara Ordinance Code, is amended as follows:

§ 4.20.110 Setback Encroachments and Height Exceptions

A. Setback Encroachment Allowance for Certain Architectural Features.

1. **General.** The following architectural features and appurtenant structures may extend into any required front, side or rear yard setback, but not beyond a property line, a distance not exceeding 30 inches beyond any legally constructed exterior wall of a dwelling:
 - a. Awnings;

b. Bay windows, limited. For purposes of this section, the bay window must be supported by framing or underpinnings higher than the finished floor level, not creating additional floor area, and the vertical distance between the surface of the interior window ledge or bench and the finished floor must be 30 inches or greater. (see definition in Ch. 1.30);

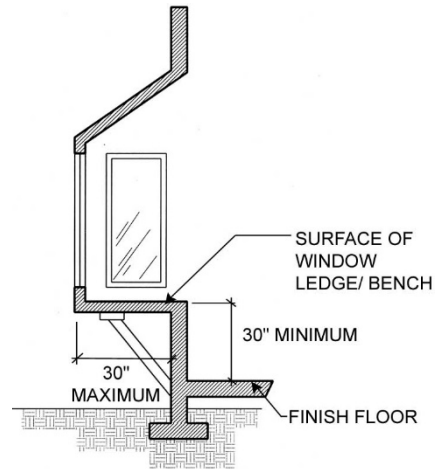

Fig.4.20-10
Bay Window

c. Chimneys;

d. Cornices;

e. Eaves;

f. Utility meters and appurtenant equipment; and

g. Architectural features similar in size and nature as determined by the Zoning Administrator.

2. **Decks, porches, and entry stairs.** Uncovered decks, porches, and entry stairs may encroach into setbacks to the extent provided in the table below. Covered porches may also encroach into the front yard setback only, to the extent provided in the table below; provided they are not enclosed by walls, screening or other such continuous vertical components. Only necessary support pillars not exceeding two (2) horizontal feet in thickness may be included. For all such decks, porches and entry stairs, a safety railing not exceeding 42 inches in height may be allowed. For the purposes of these sections, multiple decks on a building or structure will be cumulatively considered.

Yard	Maximum Encroachment Distance (feet)	Maximum Encroachment Area (square feet)
Front	6	96
Side	4	64
Rear	6	96

The limitations of this table apply only to those portions of such structures that are more than 30 inches above final grade. Decks and other structures not more than 30 inches above final grade are exempt from setback requirements, per subsection 4.20.020(B)(1).

3. **Accommodation for disabled.** Wheelchair ramps, elevators, mechanical access devices and other structures intended to facilitate access for the disabled may be exempted from setback requirements or other development standards, permit

requirements or building regulations, pursuant to the County's procedures for "Requests for Reasonable Accommodation" as defined in the County of Santa Clara Housing Element; Appendix 4 of the General Plan, and applicable state and federal regulations.

4. **Basement light-wells, access stairwells.** Basement light-wells and below-grade access stairways may encroach into residential setbacks provided their retaining walls are situated at least three (3) feet from property lines. Above-grade railings or walls around such light-wells or access stairways that are 42 inches or less in height are also exempt from residential setbacks.

B. **Height Exceptions.** The following architectural features and appurtenant structures may exceed the maximum height requirement for dwellings and accessory buildings as indicated:

1. Antennas: See subsection 4.20.020(L): Antennas.
2. Chimneys: Ten (10) additional feet maximum.
3. Decorative features such as weather vanes and open railings. Includes cupolas, and similar features, not exceeding 24 square feet in area: Five (5) additional feet maximum.
4. Solar (photovoltaic) panels mounted on roof: Five (5) additional feet maximum.
5. Air pollution control equipment required and approved by the Bay Area Air Quality Management District or other governmental regulatory agency shall have no maximum height limit, subject to obtaining Architecture & Site Approval (ASA).
6. Architectural features similar in scale and nature as the above, as determined by the zoning administrator.

C. **Special Setback Exceptions.** The following setback exceptions shall supersede the standard residential setbacks specified in any base district or lot-size combining zoning district.

1. **Side setback reduction based on area.** A lot whose area is one (1) net acre or less, and is lesser in area than the minimum lot size required by the applicable zoning district, may qualify for reduced side yard setbacks. The following table lists the allowable reduced side yards for ranges of substandard lot sizes.

SUBSTANDARD LOT AREA (net square feet)	MINIMUM SIDE YARD (feet)
3,750 – 5,000	5
5,001 – 6,000	6
6,001 – 8,000	8
8,001 – 10,000	10
10,001 – 20,000	15
20,001 – 1 acre (net)	20

Fig. 4.20-11

2. **Side setback reduction based on width.** A narrow lot (having an exceptionally large depth-to-width ratio) shall have minimum side yard setbacks equal to 20 percent of the lot width whenever such setback dimension would be lesser than would otherwise be provided for by the Zoning Ordinance. This allowance shall not, however, allow for an exterior side yard setback on a corner lot to be less than 10 feet. For the purposes of this subsection, width shall be measured across the portion of the lot where the dwelling is or will be located, and the resulting side setback shall be rounded to the nearest whole foot.

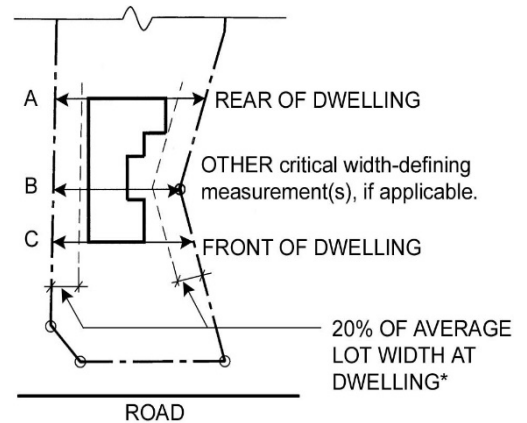

$$*A+B+C \div 3 = \text{AVERAGE LOT WIDTH}$$

$$\text{AVERAGE LOT WIDTH} \times 0.20 (20\%) = \text{SIDE YARD SETBACK}$$

3. **Rear setback reduction based on depth.** Required residential rear yard setbacks may be reduced to 20 percent of the depth of any lot. For the purposes of this subsection, depth shall be measured through the portion of the lot where the dwelling is or will be located, and the resulting rear setback shall be rounded to the nearest whole foot.

4. **Setback-nonconforming dwellings: Extension of side yard encroachment.** Any legally constructed portion of a dwelling that encroaches into a required side yard setback may be extended lengthwise along the dwelling's side wall plane, subject to the following:

- a. The new encroachment shall be limited in area to no more than 50 square feet per lot on lots located within urban service areas, and 100 square feet per lot on lots outside urban service areas. Such allowed encroachment may be adjacent to either (or both) side yard(s) provided the new encroaching area does not cumulatively exceed the applicable maximum (50 or 100 square feet). No such encroachment may extend into any front or rear yard setback.
- b. The floor area limitations of subsection A, above, shall be applied cumulatively to construction permitted after September 21, 1993.
- c. The additional area of encroachment may not be more than one story nor taller than the existing adjoining wall.
- d. No greater setback encroachment may result (i.e., the extension may be no nearer to the side property line than the existing wall being extended).
- e. No portion of a house that is less than three (3) feet from a side property line may be extended under this provision.

5. **Setback-nonconforming buildings: Roof-pitch change.** A legally constructed roof that is part of a setback-nonconforming portion of a house may be replaced by roof of the same or a different design, except where such replacement creates additional (nonconforming) floor area, as defined in Section 1.30.030.

6. **Setback-nonconforming buildings: Accessory dwelling unit additions.** A setback-nonconforming single-family residence, or setback-nonconforming accessory structure, may be expanded by no more than 150 square feet to accommodate an attached ADU, so long as the expansion does not result in a greater setback encroachment.

Fig. 4.20-12

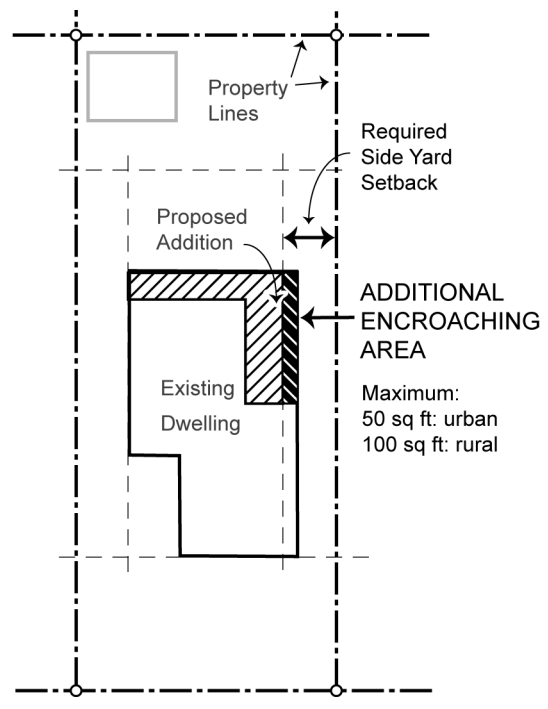

7. **Setback-nonconforming dwellings: Casualty reconstruction.** See Section 4.50.030, subsection C.
8. **Setbacks established by recorded subdivision.** The placement limitations designated by an applicable recorded subdivision map, including, but not limited to building envelopes, building lines, and setbacks shall supersede the setbacks required by this ordinance, if such limitations are more restrictive than setbacks established by the zoning ordinance.
9. **Setbacks for lots less than one acre within specified substandard subdivisions** in the HS zoning district are contained in subsection A of Section 2.20.070: Additional Development Standards for HS Districts.

D. Breezeways.

1. **Covered Walkway/Limited Breezeway.** A limited breezeway may be built to serve as an open walkway between two (2) otherwise detached buildings. The breezeway is considered exempt from the more restrictive setback requirements applicable to either of the buildings connected by the breezeway, if all the following limitations are met:

- a. The roof width, as measured perpendicular to the linear direction of travel from one building to the other, does not exceed eight (8) feet, except as needed at corners;
- b. The breezeway follows a reasonably direct path between each building; and
- c. The breezeway sides are entirely open except for necessary structural supports.

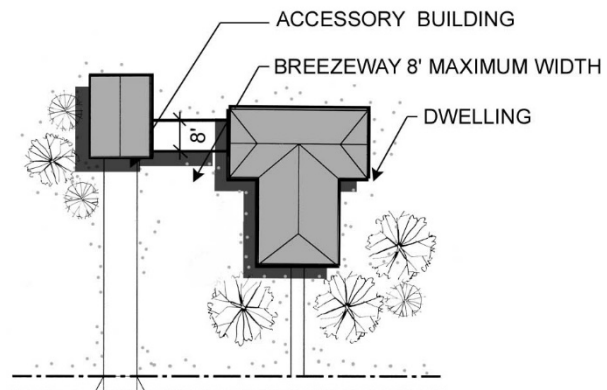

Fig. 4.20-13
Breezeways

2. **Other Breezeways.** Breezeways that exceed the above limitations, or similar structures that connect one (1) or more accessory building to a dwelling, may be allowed provided all portions of the breezeway and connected structures comply with the setbacks applicable to dwellings. Where such a breezeway connects two (2) or more accessory buildings or structures with different setback requirements, the more restrictive setbacks shall apply to all such buildings or structures.

SECTION 14. Section 4.30.030 of Chapter 4.30, Article 4 of Appendix I, Zoning, of the County of Santa Clara Ordinance Code, is amended as follows:

§ 4.30.030 Parking Spaces Required – Residential Uses

Table 4.30-1 sets forth the number of parking spaces required for each residential use.

Table 4.30-1

**Parking Spaces Required
RESIDENTIAL USES**

USE CLASSIFICATIONS	SPACES REQUIRED
Residences	
Single-Family	2 per unit (1 shall be covered)
Two-Family	2 per unit (1 per unit shall be covered)
Multi-Family	1.5 per unit
Accessory dwelling unit	
Standard (attached or detached)	1 per unit [Section 4.10.015(I)]
Movable tiny home	1 per unit [Section 4.10.015(I)]
Junior ADU	None
Agricultural Employee Housing (all)	1 per bedroom
Caretaker’s Residences	2 per residence
Home Occupations	
General	None
Expanded	1 in addition to total residential requirement
Residential – Communal Institutional	1 for each guest room, plus 1 for each employee (may be reduced if occupants normally do not have cars)
Rooming Houses, Fraternities & Sororities	1 for each guest room, plus 1 for each employee

SECTION 15. Section 4.30.070 of Chapter 4.30, Article 4 of Appendix I, Zoning, of the County of Santa Clara Ordinance Code, is amended as follows:

§ 4.30.070 Parking Design Standards

The provisions of this section apply to all off-street parking spaces unless otherwise indicated.

- A. **Residential Uses (Single-Family, Two-Family).** The following standards shall apply to residential uses, with the exception of multi-family residential, mixed-use residential, communal residences, and boarding houses:
1. Each required off-street parking space shall be at least eight and one-half (8.5) feet wide and 18 feet deep, and shall be of usable shape, location and condition.
 2. Driveways shall provide for at least 10 feet of unobstructed width between buildings and property lines. Driveway pavement (or surfacing) shall be at least eight (8) feet wide. Under certain circumstances, greater driveway width may be required by the fire marshal.
 3. Where required, covered parking may consist of an enclosed garage or open carport with at least seven (7) feet of vertical clearance. Parking structure must be located on the same lot as the residence the parking serves.
 4. In situations where two (2) parking spaces are required, tandem parking (cars lined up one behind the other) shall be permitted. In situations where more than two (2) parking spaces are required, tandem parking may be allowed, provided the parking layout provides maneuverability for at least two (2) of the spaces to have free unimpeded access to and from the street.
 5. The surface of all off-street parking areas and driveways shall be treated or paved and maintained such that ongoing use of such driveways and parking areas does not generate significant dust or mud.
 6. Not more than two (2) front yard parking spaces (or corner-lot exterior side-setback parking space) may be counted toward the minimum number of parking spaces required on a given lot.
 7. Driveways and parking areas may not be wider than 40 percent of the width of the lot's frontage along the street, measured where the driveway(s) crosses the edge of right-of-way. Driveways and parking areas cumulatively may not cover more than 40 percent of the land area of the front yard (defined in § 1.30.030). These limitations shall not apply to flag lots, any lot whose street frontage is 25 feet or less, or where the establishment of an accessory dwelling unit necessitates greater use of the front yard to achieve required off-street parking spaces pursuant to Section 4.10.015(I).

8. Vehicles may not be parked on front lawns or other portions of the front yard except designated parking and driveway areas as specified in subsections 5 and 7, above.
9. Two (2) additional off-street parking spaces for residential uses shall be provided where no on-street parking is available within 100 feet of the particular lot. One (1) additional off-street parking space shall be provided where parking is available only on one side of the street.

B. Nonresidential and Multi-Family Residential Uses. The following provisions shall apply to all uses not subject to subsection A.

1. The minimum size of parking spaces is as set forth in Table 4.30-4.

Table 4.30-4

PARKING SPACE SIZE

TYPE OF SPACE	REGULAR (W x L, in feet)	COMPACT (W x L, in feet)
Parallel to Street or Aisle	9.0 x 23.0	8.5 x 20.0
All Other	8.5 x 18	8.0 x 16.0

2. The minimum aisle width for parking areas is as follows:
 - a. For two-way traffic and double-loaded aisles the minimum aisle width is 26 feet; and
 - b. For one-way traffic, the minimum aisle width is as shown on Table 4.30-5.

Table 4.30-5

AISLE WIDTHS

PARKING ANGLES (degrees – see Figure 4.30-1)	WIDTH OF AISLE (feet)
0	12.0
30	14.0
45	15.0
60	16.0
90	20.0

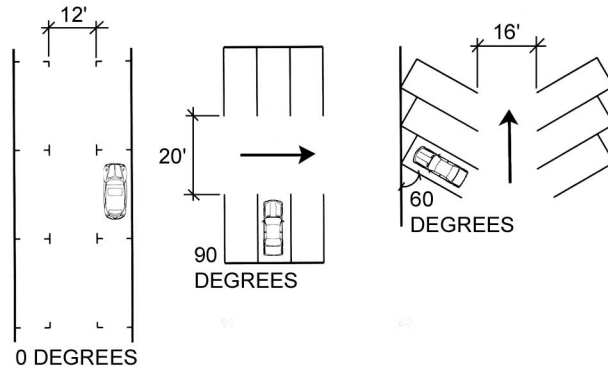
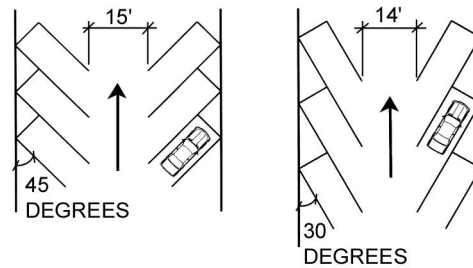

Fig. 4.30-1
Parking Spaces/ Aisles



- C. **Ingress and Egress.** Access to parking areas shall be provided as follows:
1. Access driveways for multi-family residential uses and all nonresidential uses shall have a minimum width as follows:
 - a. Two-way driveways shall have a minimum width of 22 feet; and
 - b. One-way driveways shall have a minimum width of 12 feet.
 2. Parking areas shall be designed so that a vehicle within the parking area will not have to enter a public street to move from one location to any other location within the parking area; and
 3. Vehicular access to arterial streets and highways will be permitted only in accordance with driveway locations and access design to be approved by the County Department of Roads and Airports.
- D. **Striping and Marking.** Parking facilities consisting of six (6) or more spaces shall have all parking stalls and directional arrows delineated with paint acceptable to the approval authority.
- E. **Surfacing.** Parking spaces, driveways, and maneuvering areas shall be paved and permanently maintained with asphalt or cement. Such areas shall be provided with drainage facilities adequate to dispose of all surface water accumulated within the parking area. Bumper guards shall be provided when necessary to protect adjacent

structures or properties. The approval body may modify the provisions of this subsection for surfacing located in the rural base districts. In rural areas, overflow parking for occasional special events shall be designed to be pervious.

- F. **Wheel Stops.** A wheel stop or curb, if used, shall be placed between two and one-half (2.5) and three (3) feet from the end of the parking space.
- G. **Landscaping.** Landscaping and screening shall be provided as set forth by the approving authority. Adequate physical barriers (e.g. curbs) and drainage shall be utilized to protect landscaping from impacts of vehicles.
- H. **Lighting.** All off-street parking areas within nonresidential projects shall be provided with exterior lighting which meets all of the following minimum standards:
 - 1. The equivalent of one (1) foot candle of illumination shall be provided throughout the parking area;
 - 2. All lighting shall be on a time clock or photo-sensor system;
 - 3. Parking lot illumination devices shall be high-pressure sodium vapor with 90-degree cut-off and flat lenses; and
 - 4. All lighting shall be designed to confine direct rays to the premises. Any spillover beyond the property line, except onto public thoroughfares, shall be as approved by the approving authority. Any spillover onto public thoroughfares shall not cause a hazard to motorists.
- I. **Accessible Spaces.** Designated parking spaces for individuals with disabilities shall be designed in accordance with 2013 California Building Code Chapter 11A and 11B, as amended from time-to-time.

SECTION 16. Section 5.20.070 of Chapter 5.20, Article 5 of Appendix I, Zoning, of the County of Santa Clara Ordinance Code, is amended as follows:

§ 5.20.070 Properties Subject to Annexation

- A. **Applicability.** Except as provided in subsection B, below, no application for architecture and site approval, subdivision, use permit, zone change, or for any permit for construction of a building for habitation, or for commercial or industrial use on a vacant parcel, shall be accepted for filing for any parcel of land within a city's urban service area and which is:
 - 1. Contiguous to the city; or

2. Separated from the city by the width of a public street or highway; or
3. Located within territory entirely surrounded by one (1) or more cities and adjoining a portion of a public street or highway which is no more than 300 feet in length connecting the parcel to territory within the city; unless a petition or resolution initiating annexation of the parcel to such city has been filed with the appropriate local, agency and denied, or unless the city council or its planning director has, in writing, waived the provisions of this section. In the event the parcel is located within territory which has been placed under the County's jurisdiction pursuant to California Government Code Section 35004, the landowner shall be required to file a petition with the Santa Clara County Local Agency Formation Commission (LAFCO) to detach the parcel from the city to which the parcel has previously been annexed and to annex the parcel to the city again.

B. Exceptions. This section shall not prevent the filing of any application for any or all of the following:

1. Alterations of or additions to a single-family residence, construction of accessory structures and accessory dwelling units.
2. Reconstruction (within two years) of any structure destroyed by fire, flood or other casualty beyond the control of the property owner;
3. Replacement of a structure because of condemnation proceedings;
4. Development on the lands of Stanford University, per the intergovernmental protocol agreement adopted jointly by the County of Santa Clara, Stanford University, and the City of Palo Alto.
5. Minor alterations of or additions to existing duplexes, multifamily dwellings, commercial or industrial structures where number of units is not being increased. Exemption includes construction of minor accessory structures and site improvements such as parking areas.

For the purpose of subsection (B)(5) above, "minor" shall mean changes which do not substantially alter or significantly intensify the existing primary land use. Where this is not clear as it may apply to a specific proposal, a determination shall be made mutually by the planning directors or their designees of the County and the affected city within ten (10) days of the applicant's written request for a determination. Upon their failure to agree, the matter shall be referred to the members of the Santa Clara County Local Agency Formation Commission (LAFCO), which shall henceforth constitute the County reviewing body. The determination of LAFCO shall be final.

A corresponding annexation provision applicable to building site approval may be found in Section C1-52 of the County Ordinance Code.

SECTION 17. Section 5.50.050 of Chapter 5.50, Article 5 of Appendix I, Zoning, of the County of Santa Clara Ordinance Code, is amended as follows:

§ 5.50.050 Exemptions

The following types of buildings and structures are deemed minor in character and are exempt from design review, except where any superseding “-d₁” provisions (§ 3.20.040), -sr provisions (§ 3.30.030) or “-h₁” provisions (§ 3.50.030) apply.

- A. Additions to existing buildings or structures where new floor area does not exceed 1,000 square feet;
- B. Detached accessory buildings, and structures 1,000 square feet or less in floor area;
- C. Accessory dwelling units;
- D. Decks whose floor surface is 30 inches or less above final grade, and grade-level pavement for which grading performed prior to paving does not require a grading permit;
- E. Any decks (regardless of height), carports, arbors, or other similar structures attached to a building that are 1,000 square feet or less in floor area;
- F. Fences three (3) feet or less in height;
- G. Open fences, having a composition (solid components vs open “gap” components) where not more than 25% of the surface area is solid when viewed from a position perpendicular to the fence; and that meet the applicable fence height requirements of Section 4.20.050;
- H. Retaining walls that are not subject to a grading permit;
- I. Solar energy conversion systems accessory to a principal structure or use;
- J. Swimming pools;
- K. Small wind energy systems, private antennas, and similar structures; and
- L. Up to 5,000 gallon capacity water tank(s).

The cumulative construction of multiple exempt projects on a lot may, at the discretion of the Zoning Administrator, be subject to design review, based upon the characteristics and visibility of the property, the potential visual impact of the buildings or structures, and any other relevant considerations as defined in § 5.50.040, Scope of Review.

SECTION 18. Section 5.50.060 of Chapter 5.60, Article 5 of Appendix I, Zoning, of the County of Santa Clara Ordinance Code, is amended as follows:

§ 5.50.060 Administrative Approvals and Discretionary Exemptions

The following types of buildings and structures may, at the discretion of the Zoning Administrator, be considered minor and eligible for design review administrative approval or a discretionary exemption from the design review process, except where any superseding “-d₁” provisions (§ 3.20.040), “-sr” provisions (§ 3.30.030) or “-h₁” provisions (§ 3.50.030) apply. An administrative design review approval shall be granted without a public hearing, based on applicable standards and guidelines for design review. Except for buildings or structures qualifying as Tier 1 and “Sites Not Visible” pursuant to subsection E below, the Zoning Administrator’s decision to grant either administrative approval or discretionary exemption will be based upon the characteristics and visibility of the property, the potential visual impact of the buildings or structures, and any other relevant considerations as defined in § 5.50.040, Scope of Review.

- A. Additions to existing buildings and structures, including attached carports, arbors, and similar unenclosed structures, where new floor area is between 1,001 and 2,000 square feet;
- B. Detached buildings, and structures with floor area between 1,001 and 2,000 square feet;
- C. Accessory dwelling units;
- D. Decks that exceed 1,000 square feet in area;
- E. Fences in “-d” combining districts or along designated scenic roads listed in § 3.30.050 which conform to the provisions of this ordinance regulating fence height (excluding certain “open” fences, see subsection 5.50.050(F)), and fence enclosures for tennis courts or other outdoor sports courts that exceed applicable fence height requirements of § 4.20.050 in any zoning district that are setback from property lines, easements, and rights-of-way a distance equal to their height;
- F. Projects in “-d₁” zoning districts meeting the criteria specified in Section 3.20.040 for “Tier 1” and “Sites Not Visible”, regardless of any conflicting standards within this section; and
- G. Other minor construction similar in scale to the above categories and having low potential for visual impact, including retaining walls, except where subsection 3.20.040 applies.

SECTION 19. Section 5.70.040 of Chapter 5.70, Article 5 of Appendix I, Zoning, of the County of Santa Clara Ordinance Code, is amended as follows:

§ 5.70.040 Parking Variance

For new single-family residential or two-family residential uses, or accessory dwelling units, the standard variance procedure and findings may be employed to allow a reduction in the number of required spaces, and/or the requirement for covered parking. Other uses necessitating a reduction in the number of required spaces shall be subject to § 4.30.100: Parking Exception.

SECTION 20. Section 5.20.010 of Chapter 5.20, Article 5 of Appendix I, Zoning, of the County of Santa Clara Ordinance Code, is amended to read as follows:

§ 5.20.010 Purpose

This chapter sets forth the process for obtaining discretionary planning permits and planning clearances in unincorporated areas in Santa Clara County. It applies to all permits regulated through subsequent sections of this zoning ordinance. The procedures described in this chapter also apply to other types of land development permits regulated through the County Ordinance Code, including but not limited to building site approval, subdivisions, grading permits, lot mergers, and administrative permits.

The following sections are organized to represent a step-by-step description of the land development permit application and decision-making process.

SECTION 21. Section 5.20.240 is added to Chapter 5.20, Article 5 of Appendix I, Zoning, of the County of Santa Clara Ordinance Code, to read as follows:

§ 5.20.240 Planning Clearance

Certain types of uses in unincorporated areas of Santa Clara County require an administrative planning clearance. A planning clearance is a ministerial, nondiscretionary process for uses that require adherence to the Zoning Ordinance but for which no discretionary permit is required. Uses allowed with a planning clearance require that an applicant verify and provide sufficient evidence to establish that the proposed use adheres to the Zoning Ordinance.

In such cases where a use allowed with a planning clearance requires compliance with specific development standards, the planning clearance shall include certain conditions of approval to ensure compliance with all development standards for the use. A planning clearance shall be issued prior to the issuance of any building permit or other approval required by the Ordinance Code.

The Planning Office is responsible for evaluating applications for planning clearance. There is no appeal of a planning clearance.

PASSED AND ADOPTED by the Board of Supervisors of the County of Santa Clara, State of California on MAR 10 2020 by the following vote:

AYES: **CHAVEZ, CORTESE, ELLENBERG
SIMITIAN, WASSERMAN**

NOES: **NONE**

ABSENT: **NONE**

ABSTAIN: **NONE**



CINDY CHAVEZ, President
Board of Supervisors

~~Signed and certified that a copy of this document has been delivered by electronic or other means to the President, Board of Supervisors~~
ATTEST:

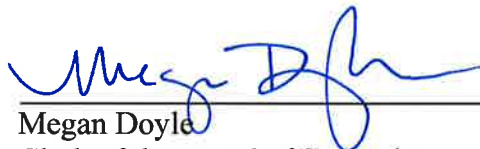

Megan Doyle
Clerk of the Board of Supervisors

APPROVED AS TO FORM AND LEGALITY:



Lizanne Reynolds 3-5-20
Deputy County Counsel